



FEATURES

- 10~14V input voltage
- Output Voltage:
 - MQ7250L12L: 0.8V~1.8V
 - MQ7250L12W: 1.2V~5.5V
- Output Current up to 10A
- Output voltage ripple: 20mV_{PP}
- High Efficiency 93%
- Margin-up /Margin-Down
- Remote on/off control – positive
- Over current /short-circuit protection
- Over-temperature protection
- Remote Sense
- EasyTrack™
- High reliability: designed to meet 5 million hour MTBF
- Minimal space on PCB:
 - 25.4 mm x 15.75mm x 9.80mm or
 - 1 in x 0.62 in x 0.39in
- Operating Temperature: -40°C to +85°C
- UL/IEC/EN60950 compliant
- RoHS Compliant available
- Remote Control Logic mode-Positive Logic
- PoLA Pin Configuration

APPLICATIONS

- Workstations, servers
- Desktop computers
- DSP applications
- Distributed power architectures
- Telecommunications equipment
- Data communications equipment
- Wireless communications equipment

Description

The **PoLA MQ7250L12** series Power Modules are non-isolated dc-dc converters that operate over a wide input voltage range of 10Vdc to 14Vdc and provide a precisely (2%) regulated dc output with industry standard pin configuration. Such a module is suitable to application with unregulated 12V power supply bus. The modules have a maximum output current rating of 8A at typical full-load efficiency over 93%. Standard features include remote on/off with positive logic and output voltage adjustment, over-current protection, over-temperature protection EasyTrack control and margin up/down. Option features include through hole or SMT, narrow or wide output trim range.

***** **Typical Application Circuit** *****

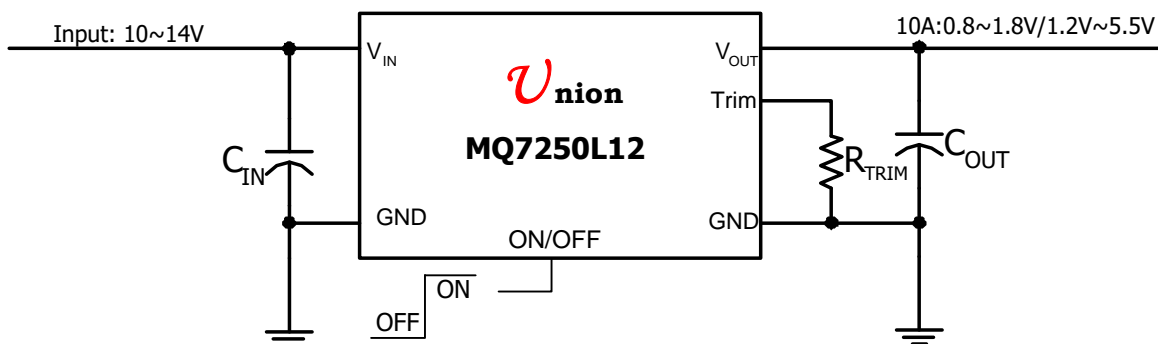

Performance Specifications (at TA=+25°C)

Model	Input V _{IN} Range (V)	Output				Efficiency (%)
		I _{OUT} (A)	Trim Range (V)	Regulation		
				Line (%)	Load (%)	
MQ7250L12L	10 ~ 14	10	0.8 ~ 1.8	0.5	0.5	88
MQ7250L12W			1.2 ~ 5.5			93

Mechanical Specifications

Dimensions are in mm (inches)

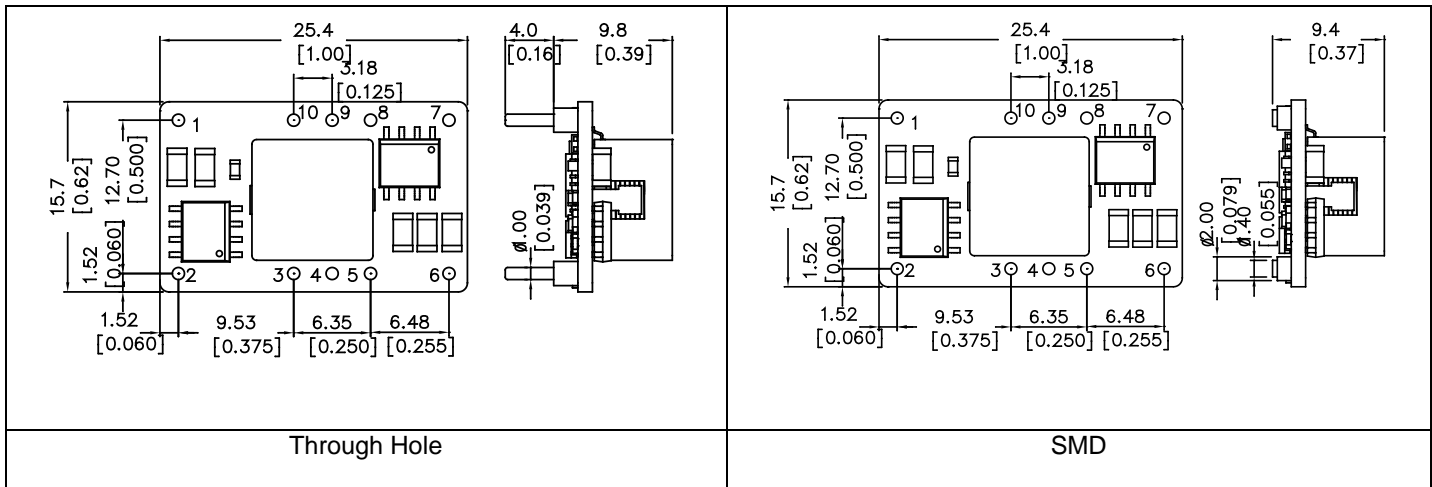

Pin	1	2	3	4	5	6	7	8	9	10
Description	GND	V _{in}	ON/OFF Control	Trim	Sense	V _{out}	GND	Easy Track™ Control	Margin Down	Margin Up

Ordering Information**MQ7250LT12W**Union Microsystems
Power module

POLA pin

S: SMD

T: Through Hole

Output Voltage Range

L: 0.8V~1.8V

W: 1.2V~5.5V

Input Voltage Range

12: 10V~14V

Absolute Maximum Ratings

Note: These are stress ratings. Exposure of devices to any of these conditions may adversely affect long-term reliability. Proper operation under conditions other than those listed in the Performance Specifications Table is not implied.

Parameter	Symbol	Min	Max	Unit
Input Voltage	V_{IN}	-0.3	14	V
Storage Temperature	T_{STG}	-40	125	°C

MQ7250L12 Electrical Specifications: ($T_A=+25^{\circ}\text{C}$)

Parameter	Condition	Symbol	Min	Typ	Max	Unit
Input Voltage Range		V_{IN}	10	12	14	V
Output Current		I_o	0		10	A
Output Voltage Set point	100% load	ΔV_o	-2		+2	%
Temperature Regulation	$T_A = T_{A,MIN}$ TO $T_{A,MAX}$	-		0.4		% $V_{O,SET}$
Remote Sense Range					0.5	V
Line Regulation	See each output's corresponding character figure					
Load Regulation						
Output Ripple and Noise Voltage						
Transient Response	$I_o=12\text{ A}, 0\sim 20\text{ MHz}$ (<i>Detail Please see corresponding figure</i>)					

General Specifications

Parameter	Condition	Symbol	Min	Typ	Max	Unit
Maximum Capacitive Load	8A resistive load + Aluminum capacitor			6600		μF
	8A resistive load + Sanyo POSCAP			2000		
Overcurrent Protection				25		A
Output short-circuit current (average)	All				0.8	A
Under Voltage Lockout Trip Level	Rising and falling V_{IN} , 3% hysteresis		7.8	8	8.2	V
Logic High (Module ON)		V_{IH}	2.5		$V_{IN,MAX}$	V
Logic Low (Module OFF)		V_{IL}	-0.7		0.3	V
Start-up Time	8A resistive load, no external output capacitors			2		mS
Switching Frequency		F_o		300		KHz
Operating Temperature	Natural convection		-40		85	°C
Vibration	3 Axes, 5 Min Each	10~55Hz, 0.35mm, 5g				
	3 Axes, 6 Times Each	Peak Deviation 300g, Settling Time 6mS				
MTBF				5,000,000		Hour

Test Configurations

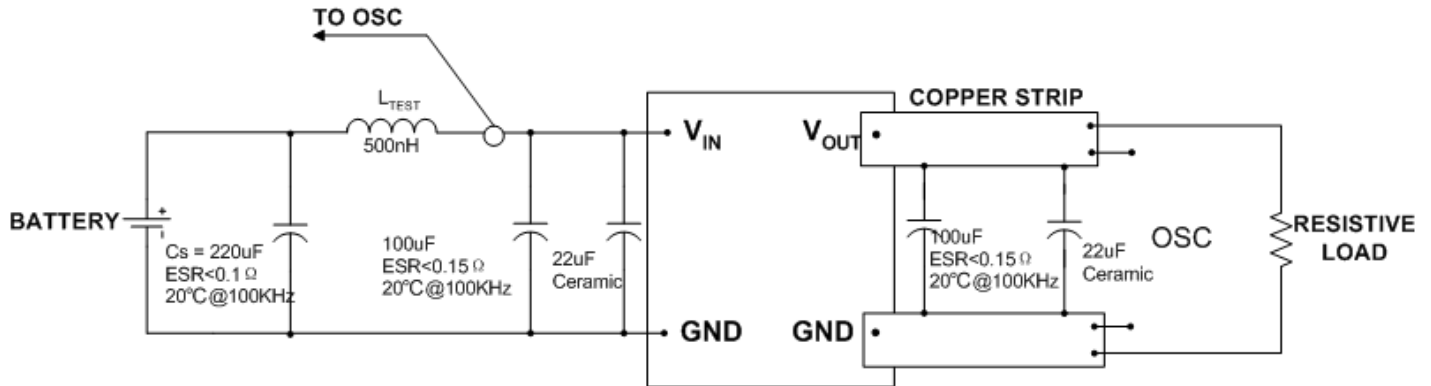

Fig 1 Test setup for input noise, output noise and ripple

Note:

Output noise is measured with 0.1 μ F ceramic capacitor connected at the output. OSC measurement should be made using a BNC socket.

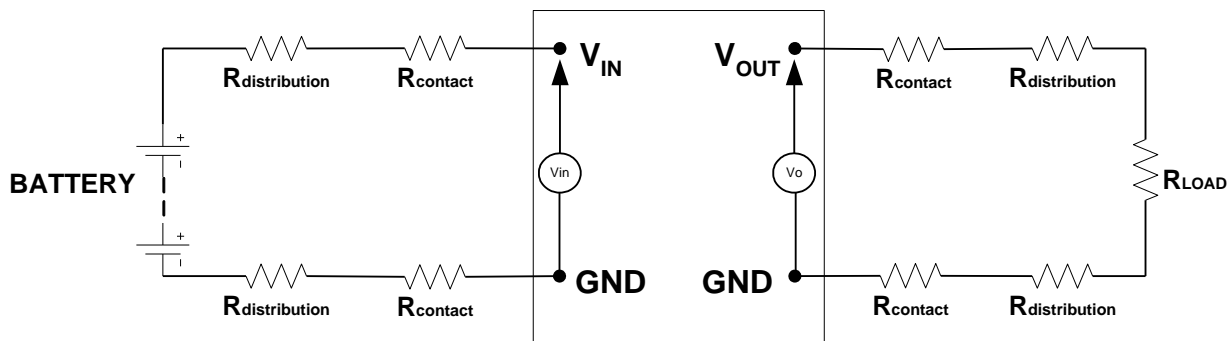

Fig 2 Test setup for efficiency

Note:

All voltage measurements must be taken at the module's terminals, as shown above. If sockets are needed, Kelvin connections are required at the module terminals to avoid measurement errors due to socket contact resistance.

Technical Notes

EasyTrack™ Function

The EasyTrack™ function is available with the all “Point-of-Load Alliance” (POLA) products. EasyTrack™ was designed to simplify the amount of circuitry required to make the output voltage from each module power up and power down in sequence. The sequencing of two or more supply voltages during power up is a common requirement for complex mixed-signal applications, that use dual-voltage VLSI ICs such as DSPs, micro-processors, and ASICs.

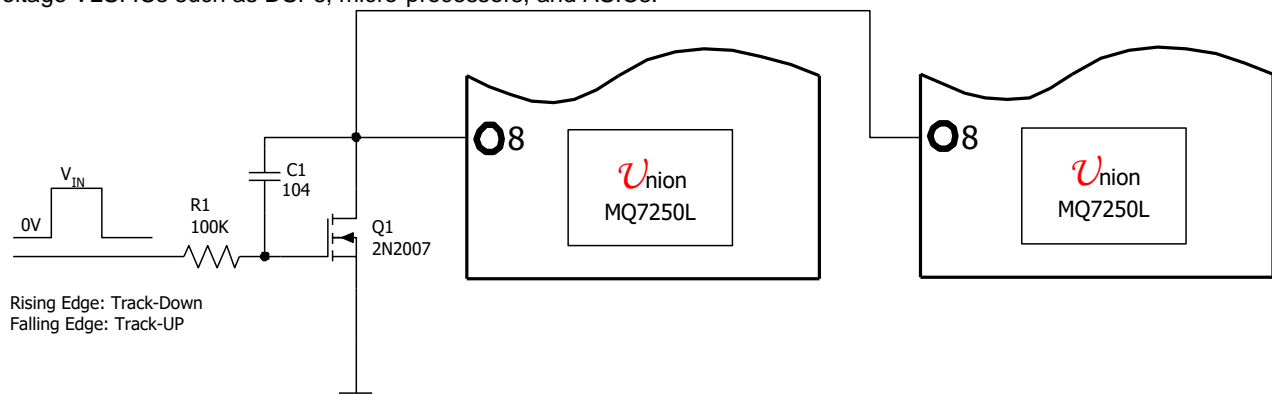

Fig3 Simultaneous Power Up and Power Down Using EasyTrack™

How *EasyTrack*TM Works

*EasyTrack*TM works by forcing the module's output voltage to follow a voltage presented at the *EasyTrack*TM control pin. This control range is limited to between 0 V and the module's set-point voltage. Once the *EasyTrack*TM control pin voltage is raised above the set-point voltage, the module's output remains at its set-point. As an example, if the *EasyTrack*TM control pin of a 2.5-V regulator is at 1 V, the regulated output will be 1 V. But if the voltage at the *EasyTrack*TM control pin rises to 3 V, the regulated output will not go higher than 2.5 V. When under *EasyTrack*TM control, the regulated output from the module follows the voltage at its *EasyTrack*TM control pin on a volt-for-volt basis. By connecting the *EasyTrack*TM control pin of a number of these modules together, the output voltages will follow a common signal during power-up and power-down. The control signal can be an externally generated master ramp waveform, or the output voltage from another power supply circuit. For convenience the *EasyTrack*TM control incorporates an internal RC charge circuit. This operates off the module's input voltage to provide a suitable rising voltage ramp waveform.

Input Voltage Range

The MQ7250L12 Series can be used in a wide variety of applications, esp. most of unregulated 12V intermediate power supply bus system. Its wide input voltage ranges can tolerate worst voltage drop from cheap isolated Brick-type Bus-converter, so it reduces total system cost on power supply.

Return Current Paths

The MQ7250L12 Series are non-isolated DC/DC converters. Their two Common pins (pins 1 and 7) are connected to each other internally. To the extent possible with the intent of minimizing ground loops, input return current should be directed through pin 1 (also referred to as---Input or Input Return), and output return current should be directed through pin 7 (also referred to as---Output or Output Return) as short as possible.

I/O Filtering

All the specifications of the MQ7250L12 Series are tested with specified output capacitors. However, certain input capacitors are necessary to improve the power modules' operating conditions and to reduce the ac impedance. For example, under some conditions, the power modules can't normally start up when fully loaded due to the high ac-impedance input source. External input capacitors serve primarily as energy-storage devices. They should be added close to the input pins of the MQ7250L12 and selected for bulk capacitance (at appropriate frequencies), low ESR, and high rms-ripple-current ratings. All external capacitors should have appropriate voltage ratings. To reduce the amount of ripple current fed back to the input supply (input reflected-ripple current), an external L-C filter can be added with the inductance as close to the power module as possible.

MQ7250L12's output ripple and transient response can be improved with the increasing output capacitance. When using output capacitors, take care that the total output capacitance does not exceed MQ7250L12's Maximum Capacitive Load to avoid issuing the module's over-current protection mechanism in the start-up procedure.

When an external L-C filter is added to reduce ripple on load, for best results, the filter components should be mounted close to the load circuit rather than the power module.

When testing the relationship between external capacitors and output voltage noise, the oscilloscope's probe should be applied to the module's end directly with scope probe ground less than 10mm in length.

Input Fusing

The MQ7250L12 Series is not internally fused. Certain applications and/or safety agencies may require the installation of fuses at the inputs of power conversion components. The selection of the fuses should conform to the following:

1. The fuse value should be selected to be greater than the maximum input current of the modules, which occurs at the minimum input voltage.
2. Use either slow-blow or normal-blow fuses.
3. Both input traces must be capable of carrying a current of 1.5 times the value of the fuse without opening.

Margin Up/Down Controls

The MQ7250L incorporate *Margin Up* and *Margin Down* control inputs which allow the output voltage to be momentarily adjusted, either up or down, by a nominal 5%. This provides a convenient method for dynamically testing the operation of the load circuit over its supply margin or range. It can also be used to verify the function of supply voltage supervisors. Pulling the appropriate margin control input directly to the GND terminal makes the 5% adjustment. Adding series resistors to the control inputs can also accommodate adjustments of less than 5%. Detailed implemented circuit refers to Fig4. The value of the resistor can be selected from Table 1.

If these functions are not been used, just leave these pins float and be care of that Margin up and Margin down cannot be activated simultaneously, connect the ground reference directly to the **Output Return GND** as short as possible.

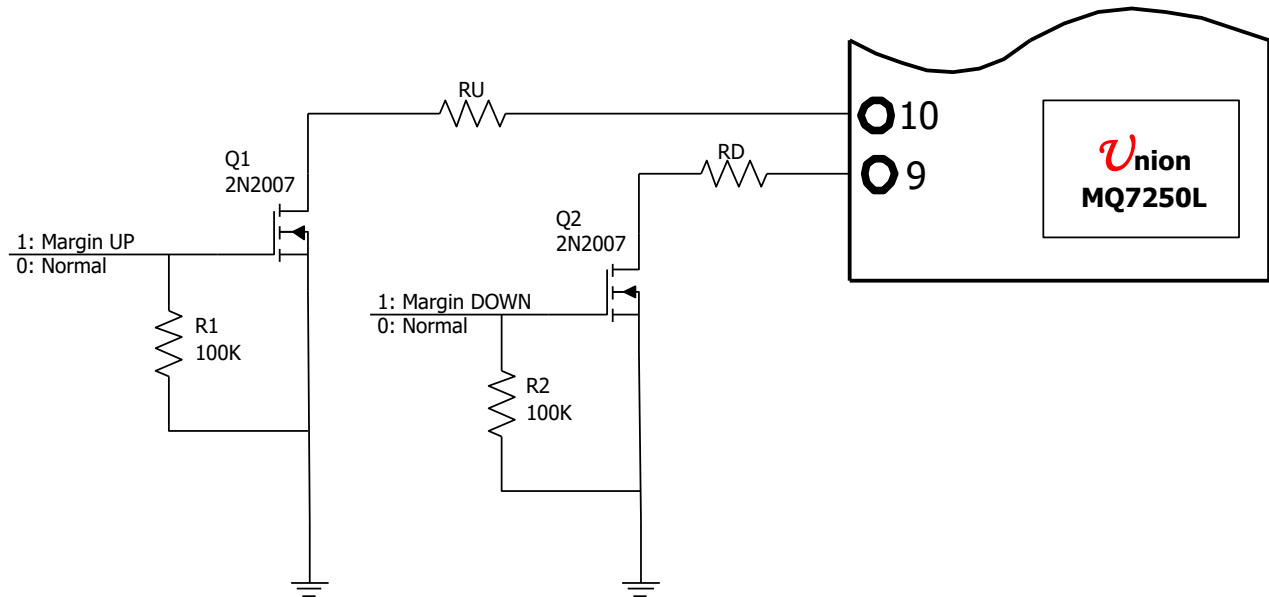

Fig4 Margin up and Margin down application circuit

UP/Down adjust resistor calculation:

$$RU \text{ or } RD = \frac{499}{\Delta\%} - 99.8$$

Resistor values are in k Ω ; $\Delta\%$ is desired amount of margin adjust in percent.

Table 1 Margin Up/Margin Down Resistor Values

%Adjust	R_U/R_D
1	397.0 k Ω
2	150.0 k Ω
3	66.5 k Ω
4	24.9 k Ω
5	0k Ω

Safety Considerations

MQ7250L12's are non-isolated DC/DC converters. In general, all DC-DC's must be installed in compliance with relevant safety-agency specifications (usually UL/IEC/EN60950). In particular, for a non-isolated converter's output voltage to meet SELV (safety extra low voltage) requirements, its input must be SELV compliant. If the output needs to be ELV (extra low voltage), the input must be ELV.

Remote Sense

MQ7250L12 Power Modules offer a positive output sense function on pin SENSE. The sense function enables point-of-use regulation for overcoming moderate IR drops in conductors and/or cabling. The sense line carries very little current and consequently requires a minimal cross-sectional-area conductor. As such, it is not a low-impedance point and must be treated with care in layout and cabling. Sense lines should be run adjacent to signals (preferably ground). If the remote sense is not needed the sense pin should be left open or connected to V_{OUT} directly.

Use of trim and sense functions can cause the output voltage to increase, thereby increasing output power beyond the MQ7250L12's specified rating. Therefore:

$$V_{OUT} \text{ (at pins)} \times I_{OUT} \leq P \text{ (rated output power)}$$

ON/OFF Control

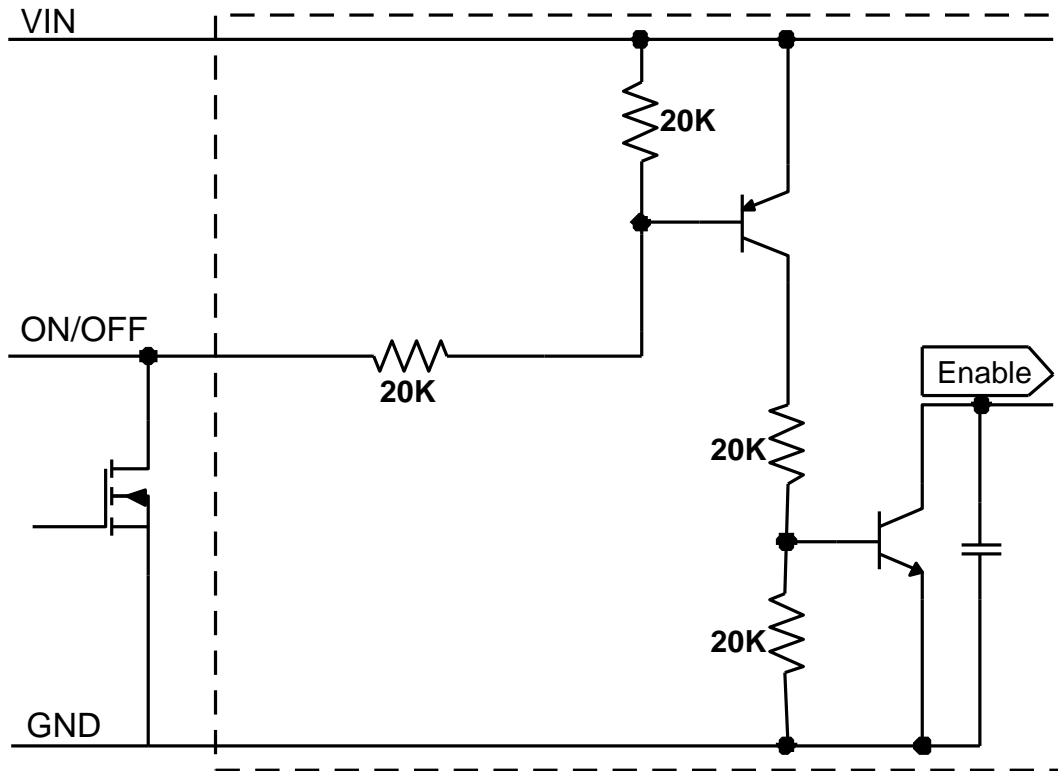

Fig5, Remote ON/OFF Implementation with Open Collector/Drain transistor for positive logic control

The MQ7250L12 power modules feature an On/Off pin for remote On/Off operation with positive logic. If not using the remote On/Off pin, leave the pin open (module will be On). The On/Off pin signal ($V_{on/Off}$) is referenced to ground. To switch module on and off using remote On/Off, refer to Figure 5.

Output Over voltage Protection

MQ7250L12 Series products do not incorporate output over voltage protection. If the operating circuit requires protection against abnormal output voltage, voltage-limiting circuitry must be provided external to the power module.

Output Overcurrent Protection (OCP)

MQ7250L12 incorporates overcurrent and short circuit protection. If the load current exceeds the overcurrent protection setpoint, the MQ7250L12's internal overcurrent-protection circuitry immediately turns off the module, which then goes into Hiccup mode. The unit operates normally once the output current is brought back into its specified range. The typical average output current during hiccup is less than 2~3A.

Caution: Be careful never to operate MQ7250L12 in a "heavy overload" condition that is between the rated output current and the overcurrent protection setpoint. This can cause permanent damage to the components.

Output Voltage Trimming

MQ7250L12's output voltage can be trimmed in certain ranges. See Figure 6 for the programming method. See performance Specifications for allowable trim ranges in detail. Also customized products are offered.

Trim with external resistor (Fig 6), the equation as below:

For MQ7250L12L:

$$R_{TRIM} = \frac{8000}{V_o - 0.8} - 7870$$

For MQ7250L12L:

$$R_{TRIM} = \frac{8000}{V_o - 1.2} - 1820$$

Resistor values are in Ω ; V_o is desired output voltage.

For examples, if trim the output of MQ7280L12L to 1.5V, then

$$R_{TRIM} = \frac{8000}{1.5 - 0.8} - 7870 = 3558$$

So, $R_{TRIM} = 3.558k\Omega$

If trim the output of MQ7280L12W to 1.5V, then

$$R_{TRIM} = \frac{8000}{1.5 - 1.2} - 1820 = 24846$$

So, $R_{TRIM} = 24.9k\Omega$

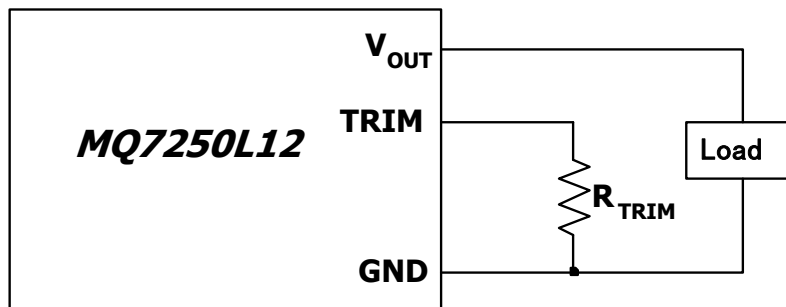

Fig6. Circuit configuration for programming output voltage using external resistor

For most common voltages, the required Trim resistors as Table 2.

Table 2, the required trim resistors R_{TRIM} for most common voltages

MQ7250L12L		MQ7250L12W	
R_{TRIM}	V_{OUT}	R_{TRIM}	V_{OUT}
N/A	0.8V	N/A	1.2V
32.1K	1.0V	24.9K	1.5V
12.1K	1.2V	11.5K	1.8V
3.56K	1.5V	4.33K	2.5V
130 Ω	1.8V	1.99K	3.3V
		285 Ω	5.0V

Typical Characteristics – output adjusted to 0.8V

General conditions:

Input filter 22µF Ceramic + 68µF TAN+470µF AL, Output filter 22µF Ceramic + 100µF TAN

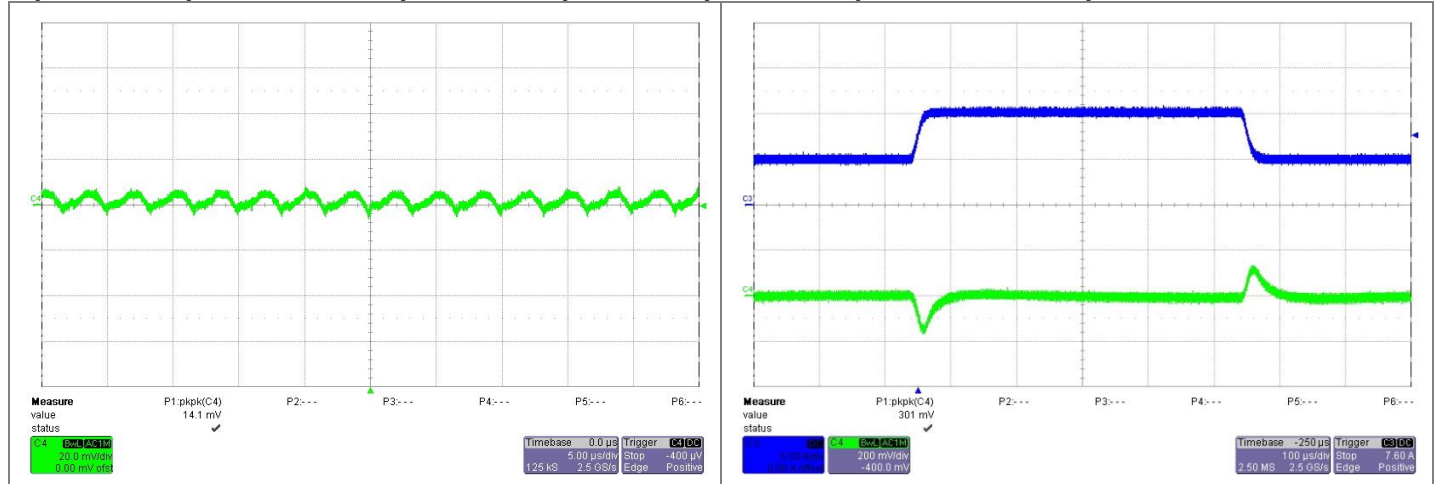

Noise $V_{IN}=12V$, $I_O=8A$, 5~20MHz Bandwidth

Transient Response $V_{IN}=12V$, Step from 4A~8A~4A
 Blue: Output Current Yellow: Output Ripple

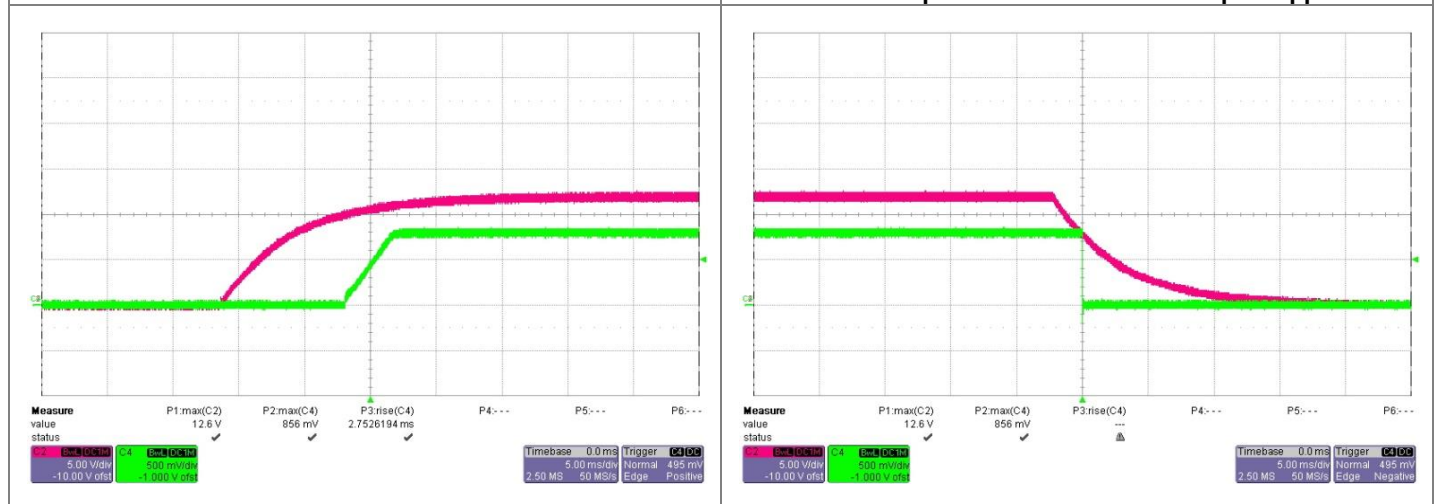

Start-up $V_{IN}=12V$, $I_O=8A$
 Red: Input Voltage Yellow: Output Voltage

Shut-down $V_{IN}=12V$, $I_O=8A$
 Red: Input Voltage Yellow: Output Voltage

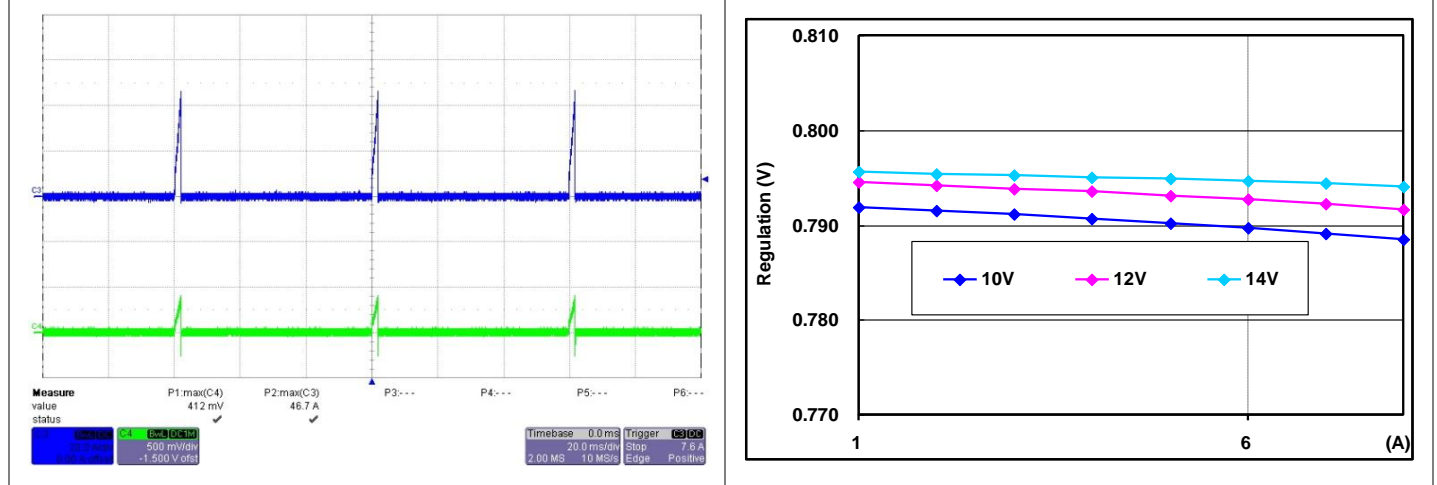

Short-Circuit Output $V_{IN}=12V$

Regulation Output voltage vs. Load Current

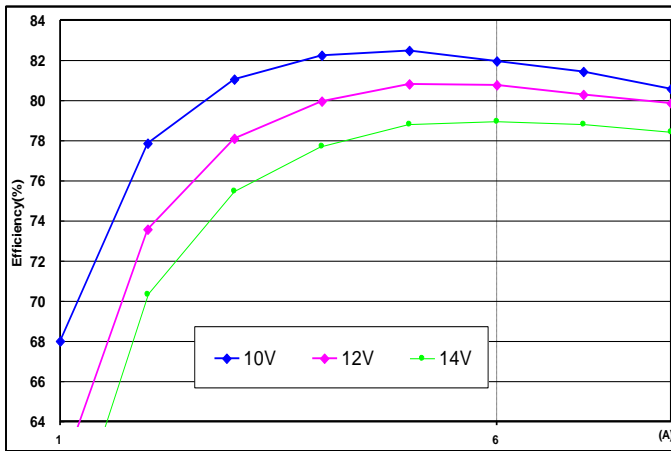

Efficiency vs. Load Current

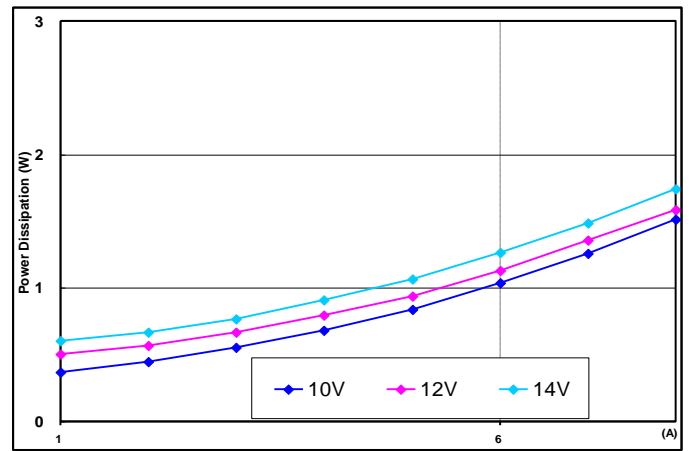

Power Dissipation vs. Load Current

Typical Characteristics – output adjusted to 1.0V

General conditions:

Input filter 22µF Ceramic + 68µF TAN+470µF AL, Output filter 22µF Ceramic + 100µF TAN

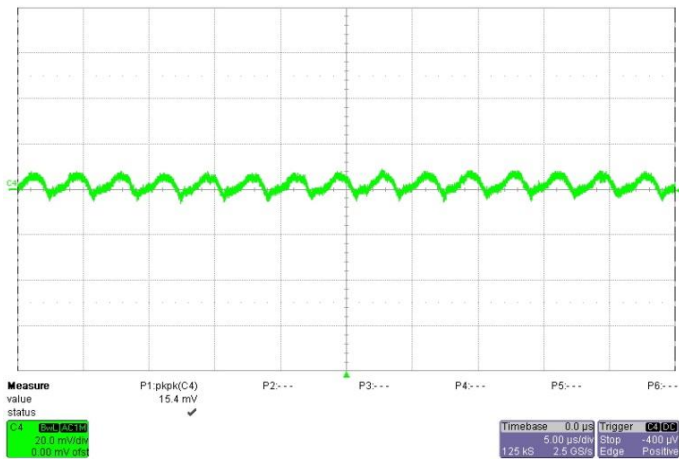

Noise $V_{IN}=12V$, $I_O=8A$, 5~20MHz Bandwidth

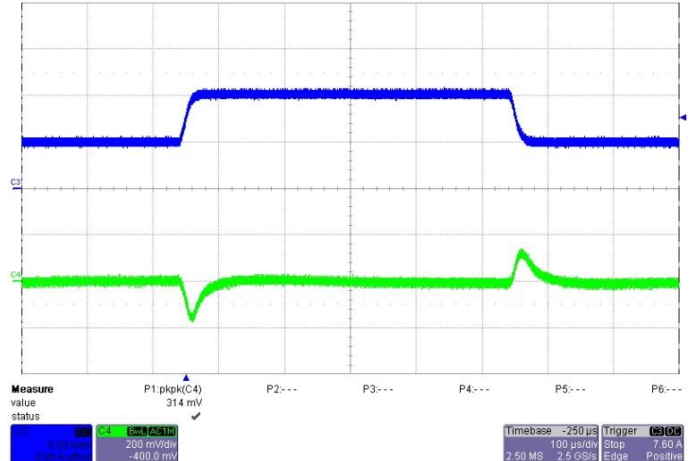

Transient Response $V_{IN}=12V$, Step from 4A-8A-4A
Blue: Output Current Yellow: Output Ripple

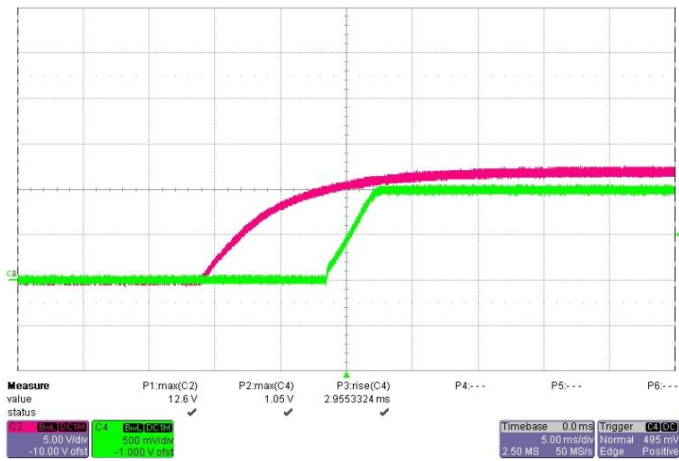

Start-up $V_{IN}=12V$, $I_O=8A$
Red: Input Voltage Yellow: Output Voltage

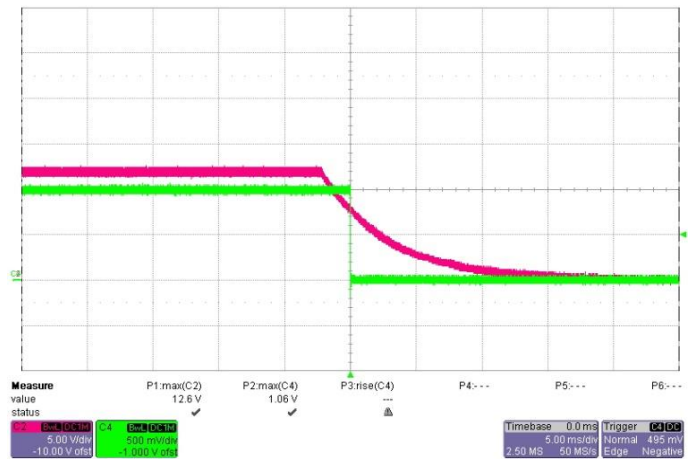

Shut-down $V_{IN}=12V$, $I_O=8A$
Red: Input Voltage Yellow: Output Voltage

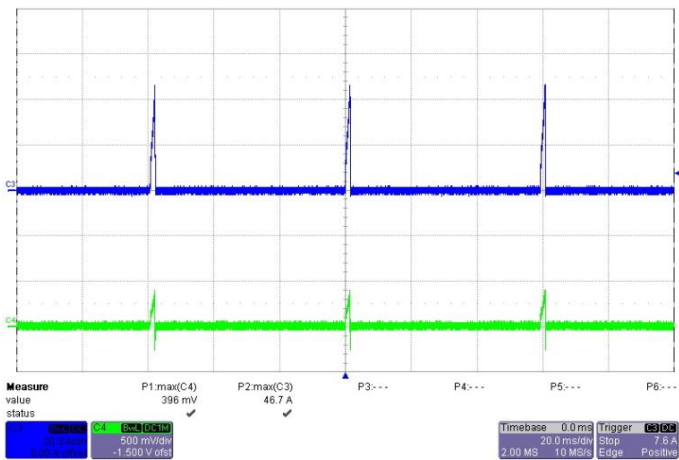

Short-Circuit Output $V_{IN}=12V$

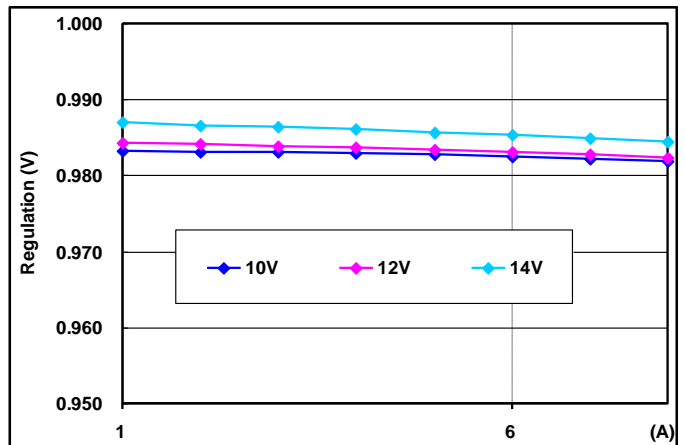

Regulation
Output voltage vs. Load Current

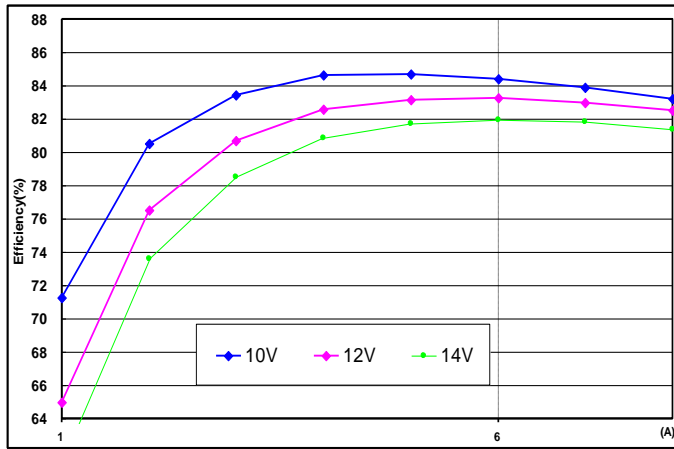

Efficiency vs. Load Current

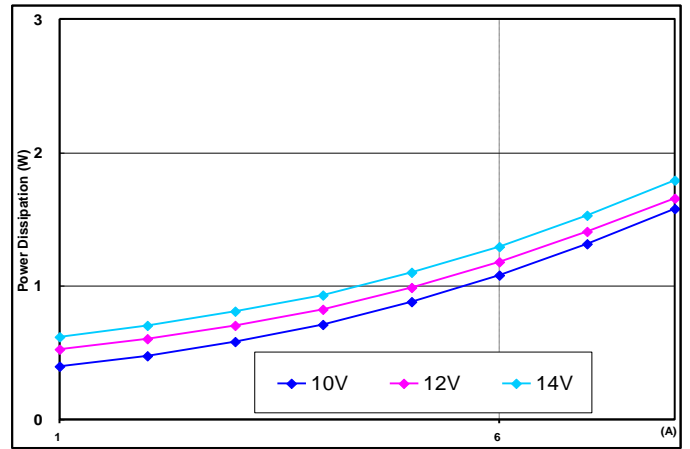

Power Dissipation vs. Load Current

Typical Characteristics – output adjusted to 1.2V

General conditions:

Input filter 22µF Ceramic + 68µF TAN+470µF AL, Output filter 22µF Ceramic + 100µF TAN

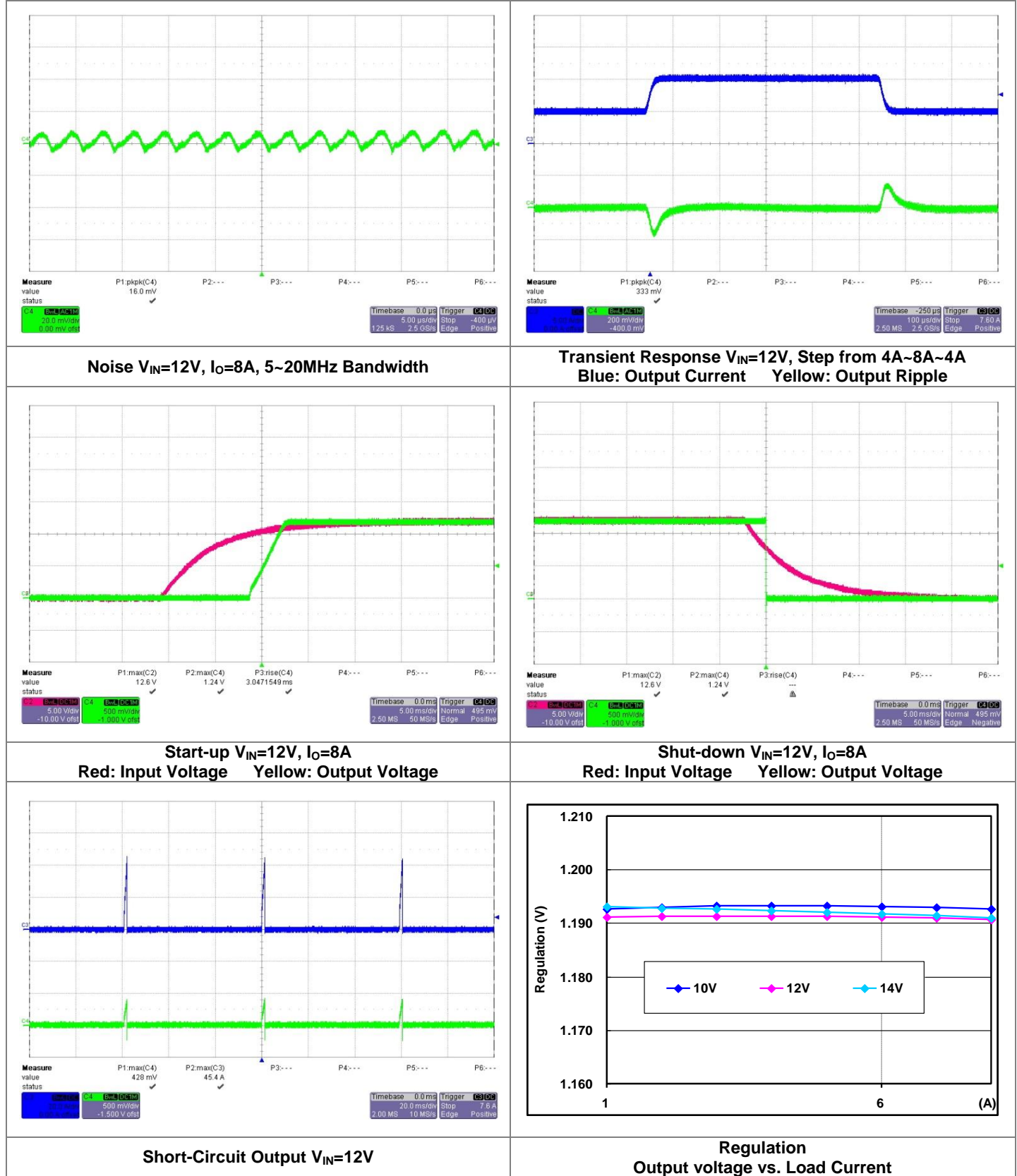

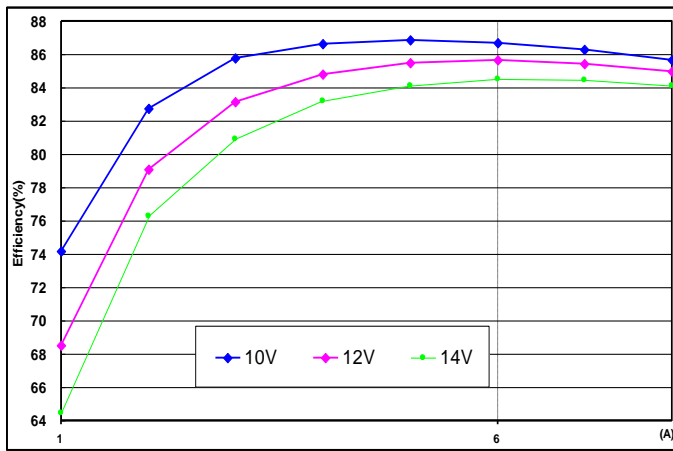

Efficiency vs. Load Current

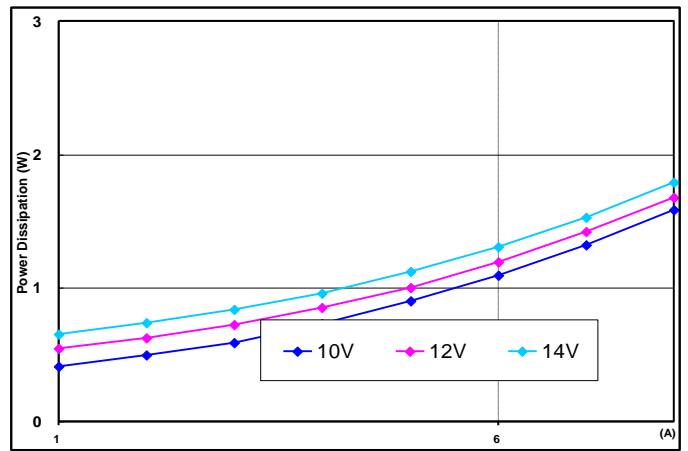

Power Dissipation vs. Load Current

Typical Characteristics – output adjusted to 1.5V

General conditions:

Input filter 22µF Ceramic + 68µF TAN+470µF AL, Output filter 22µF Ceramic + 100µF TAN

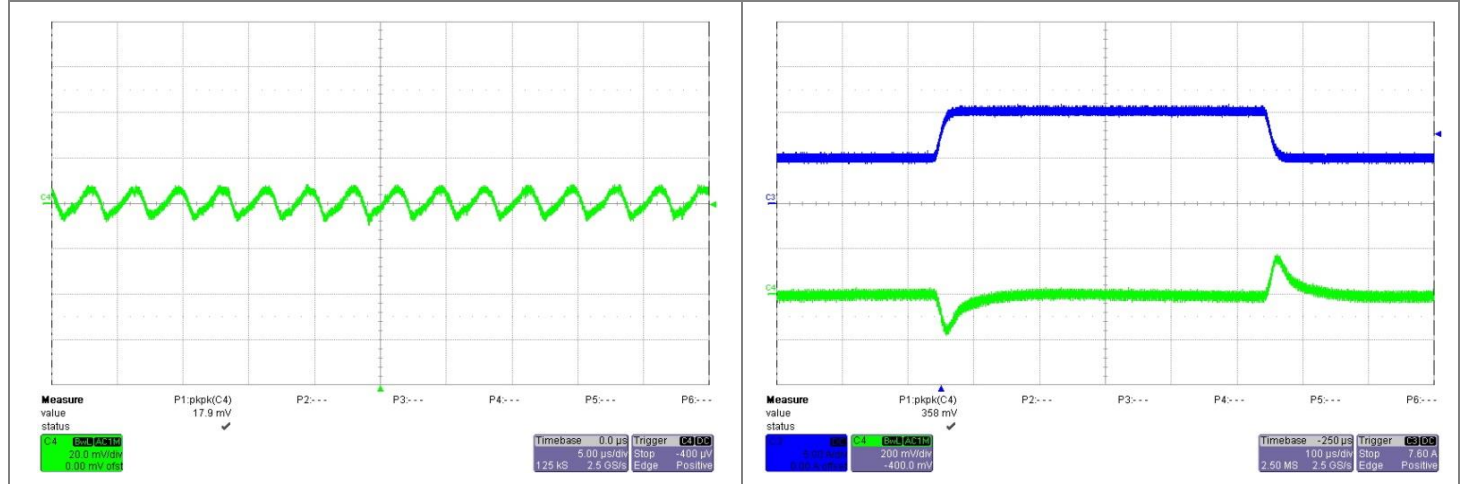

Noise $V_{IN}=12V, I_O=8A, 5\text{-}20\text{MHz}$ Bandwidth

Transient Response $V_{IN}=12V$, Step from 4A-8A-4A
Blue: Output Current Yellow: Output Ripple

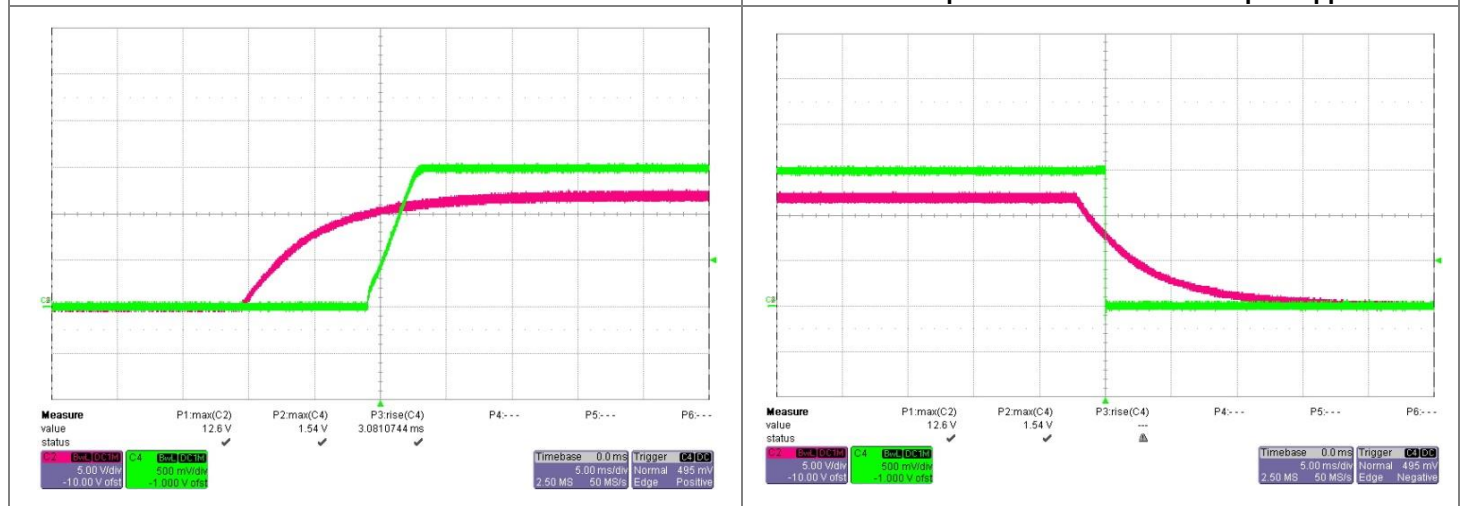

Start-up $V_{IN}=12V, I_O=8A$
Red: Input Voltage Yellow: Output Voltage

Shut-down $V_{IN}=12V, I_O=8A$
Red: Input Voltage Yellow: Output Voltage

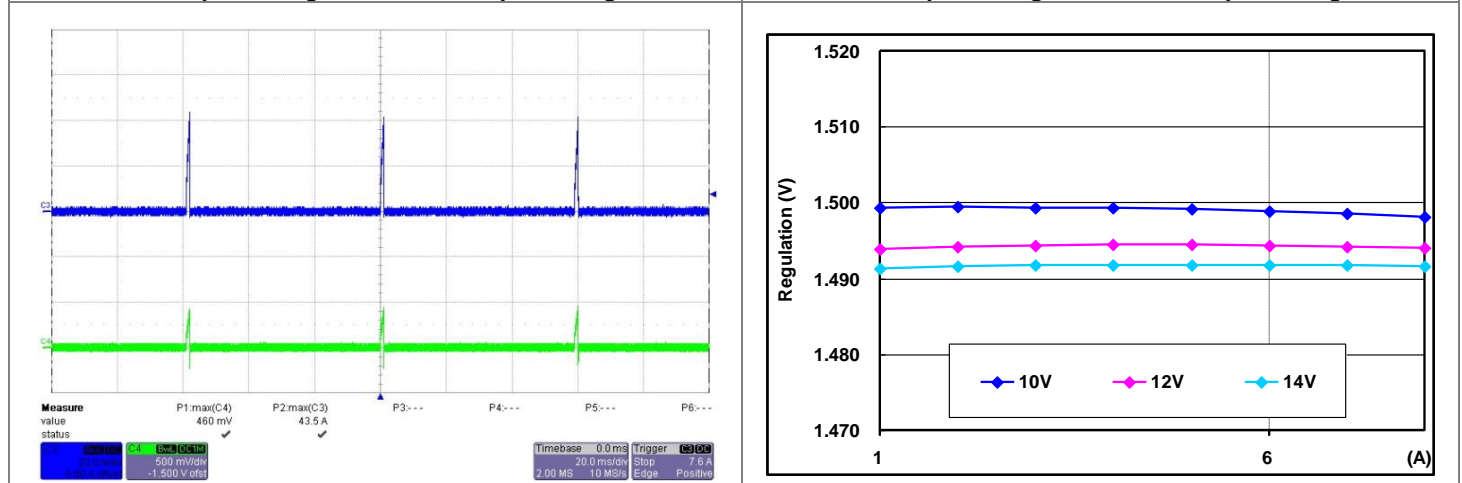

Short-Circuit Output $V_{IN}=12V$

Regulation
Output voltage vs. Load Current

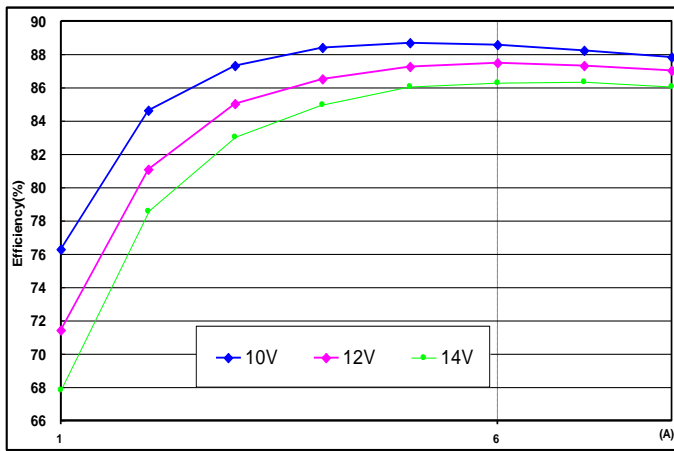

Efficiency vs. Load Current

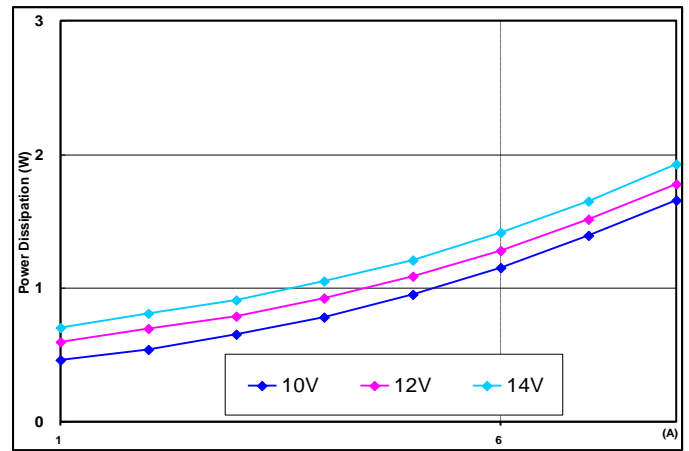

Power Dissipation vs. Load Current

Typical Characteristics – output adjusted to 1.8V

General conditions:

Input filter 22µF Ceramic + 68µF TAN+470µF AL, Output filter 22µF Ceramic + 100µF TAN

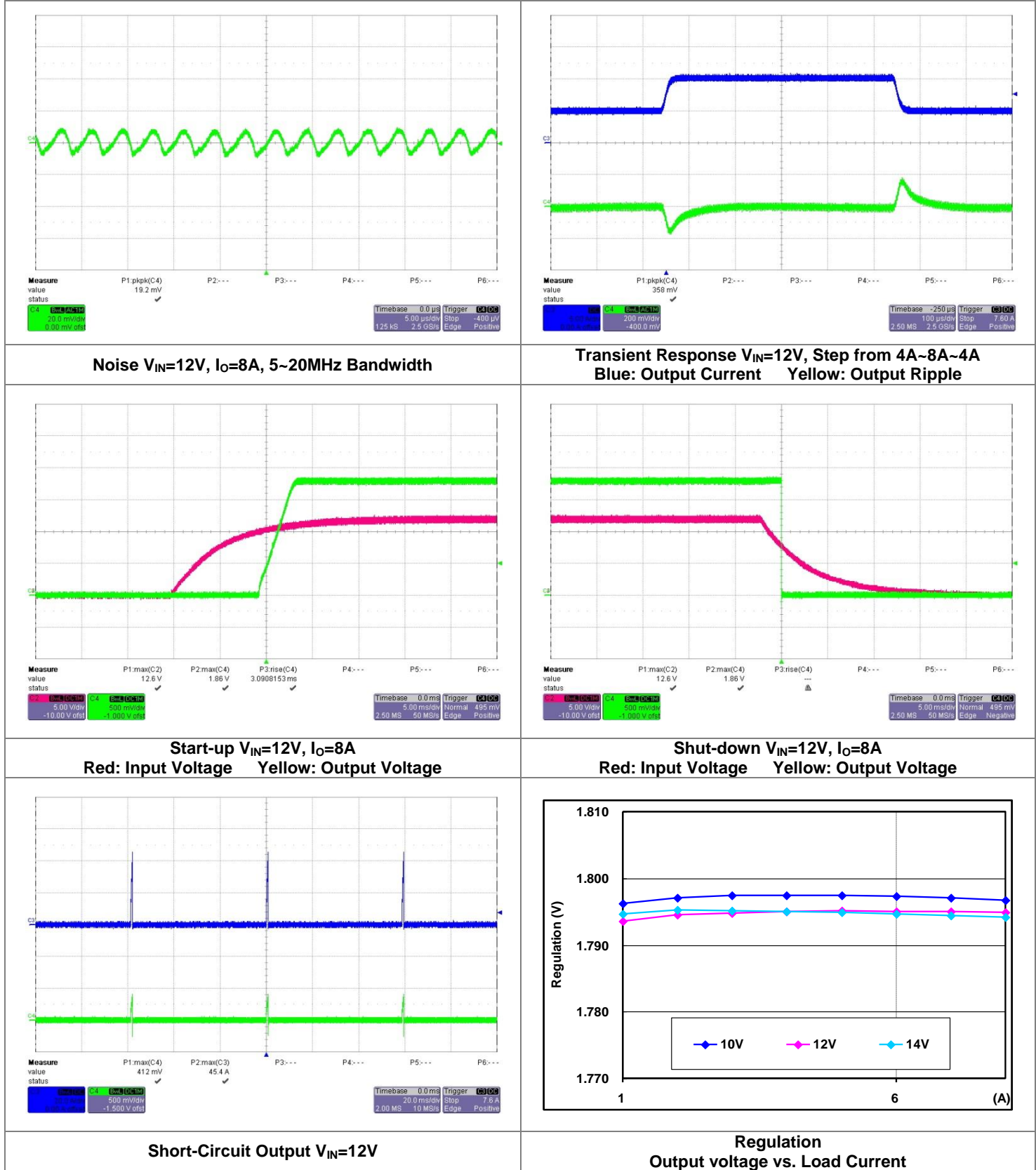

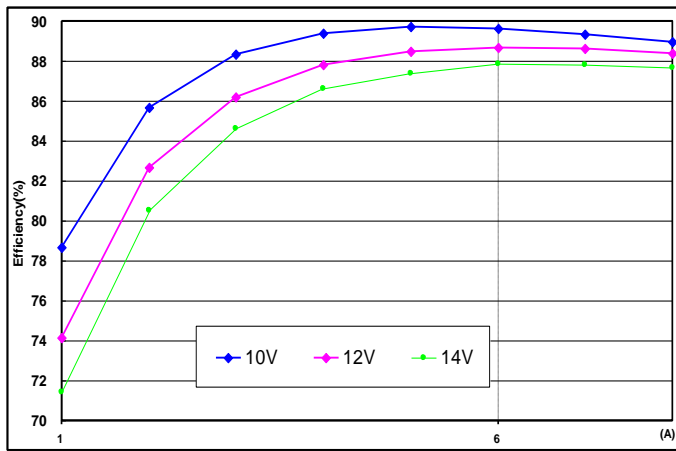

Efficiency vs. Load Current

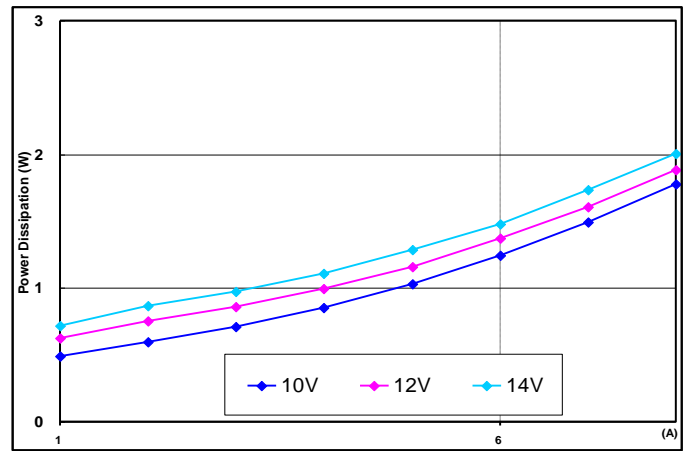

Power Dissipation vs. Load Current

Typical Characteristics – output adjusted to 2.5V

General conditions:

Input filter 22µF Ceramic + 68µF TAN+470µF AL, Output filter 22µF Ceramic + 100µF TAN

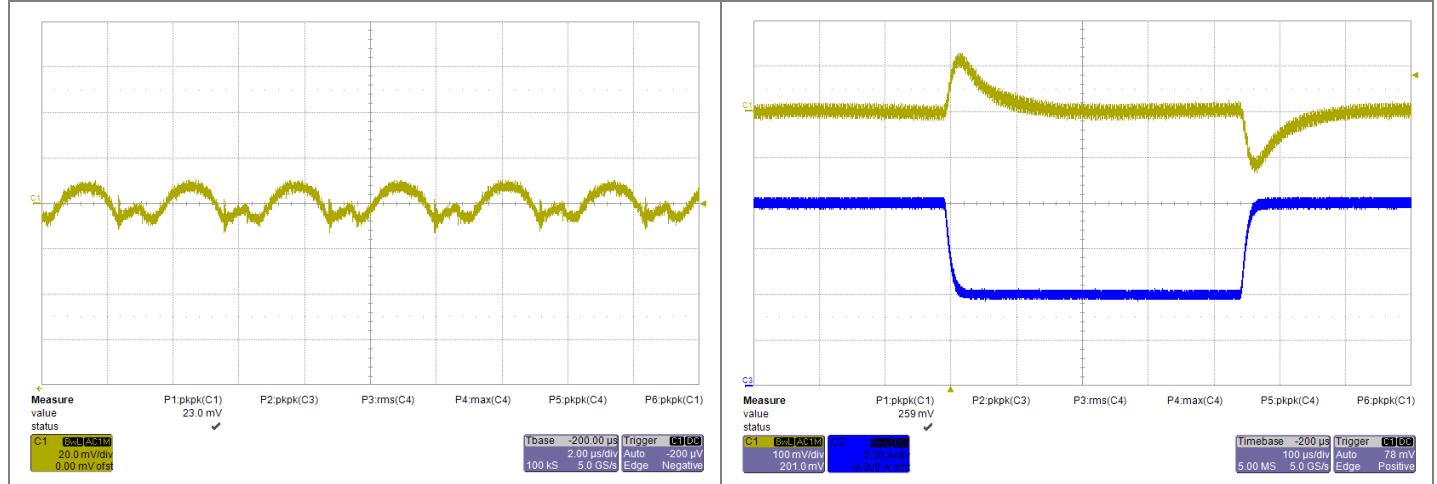

Noise $V_{IN}=12V$, $I_O=8A$, 5~20MHz Bandwidth

Transient Response $V_{IN}=12V$, Step from 4A~8A~4A
Blue: Output Current Yellow: Output Ripple

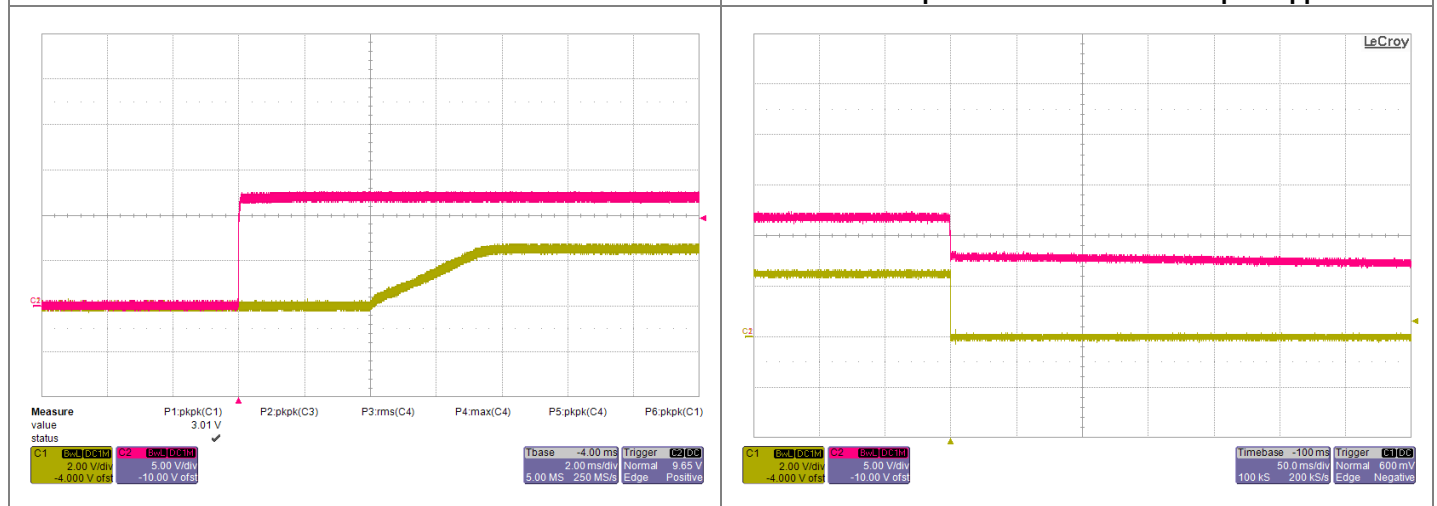

Start-up $V_{IN}=12V$, $I_O=8A$
Red: Input Voltage Yellow: Output Voltage

Shut-down $V_{IN}=12V$, $I_O=8A$
Red: Input Voltage Yellow: Output Voltage

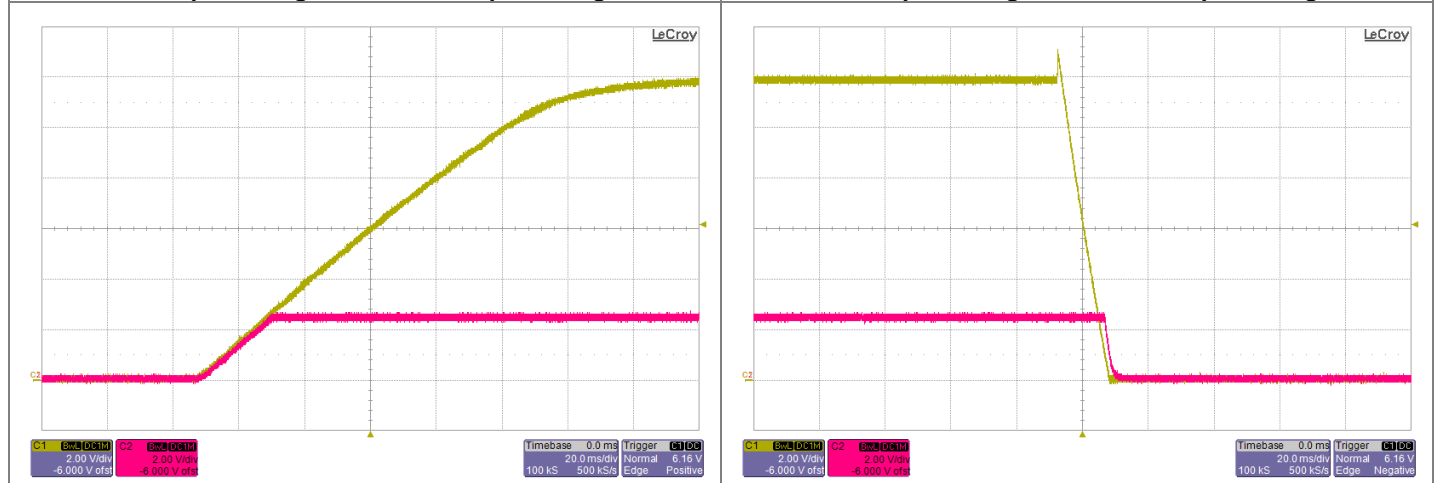

Power Up with Auto-Track Control $V_{Track}=5.0V$, $I_O=8A$
Red: EasyTrack™ Control Voltage Yellow: Output Voltage

Power Down with Auto-Track Control $V_{Track}=5.0V$, $I_O=8A$
Red: EasyTrack™ Control Voltage Yellow: Output Voltage

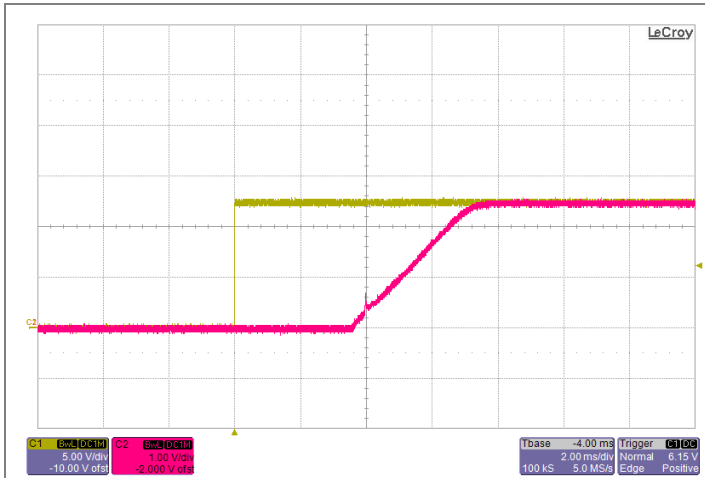

Power Up with ON/OFF Control
Red: ON/OFF Control Voltage Yellow: Output Voltage

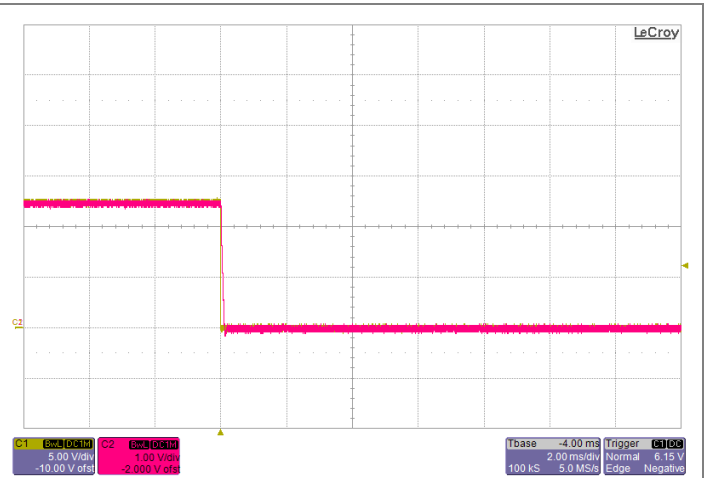

Power Down with ON/OFF Control
Red: ON/OFF Control Voltage Yellow: Output Voltage

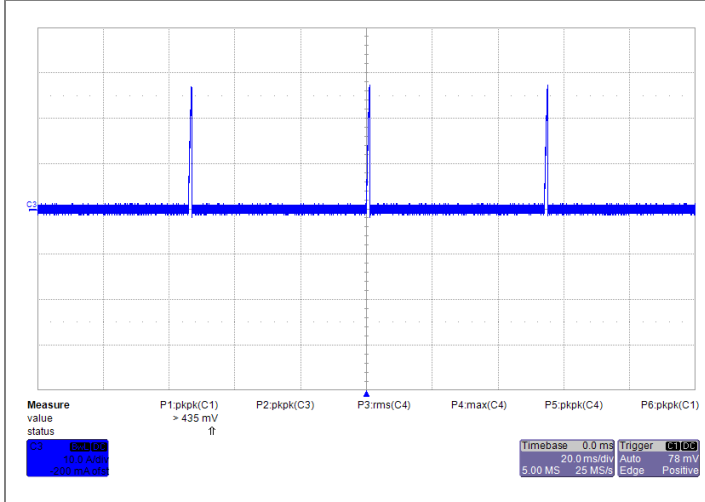

Short-Circuit Output $V_{IN}=12V$

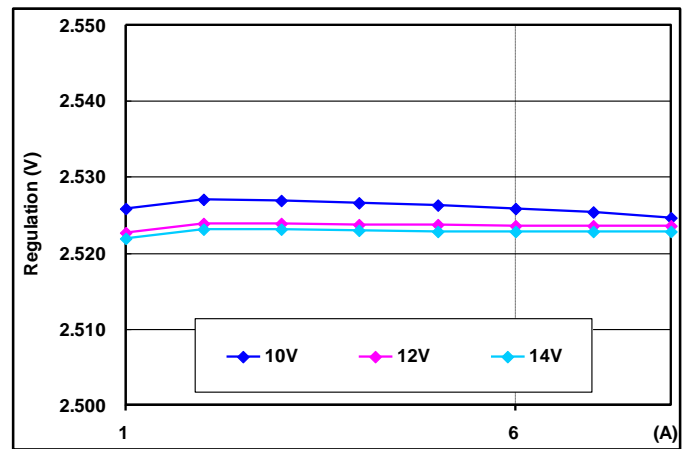

Regulation
Output voltage vs. Load Current

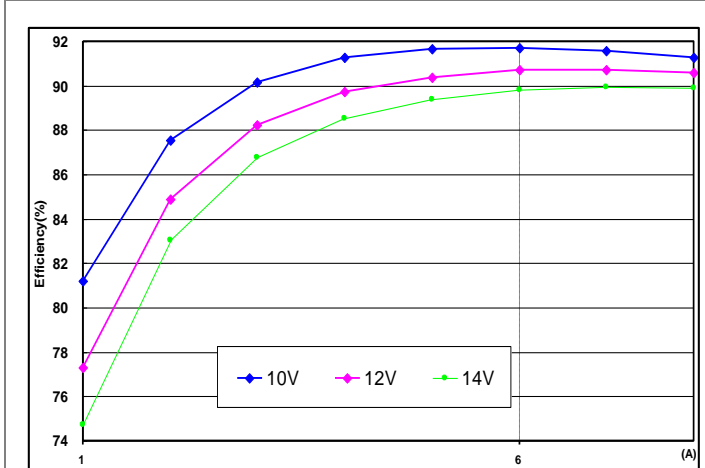

Efficiency vs. Load Current

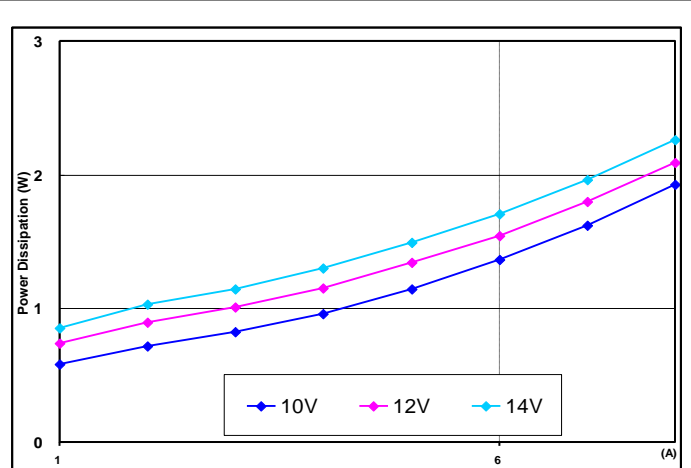

Power Dissipation vs. Load Current

Typical Characteristics – output adjusted to 3.3V

General conditions:

Input filter 22µF Ceramic + 68µF TAN+470µF AL, Output filter 22µF Ceramic + 100µF TAN

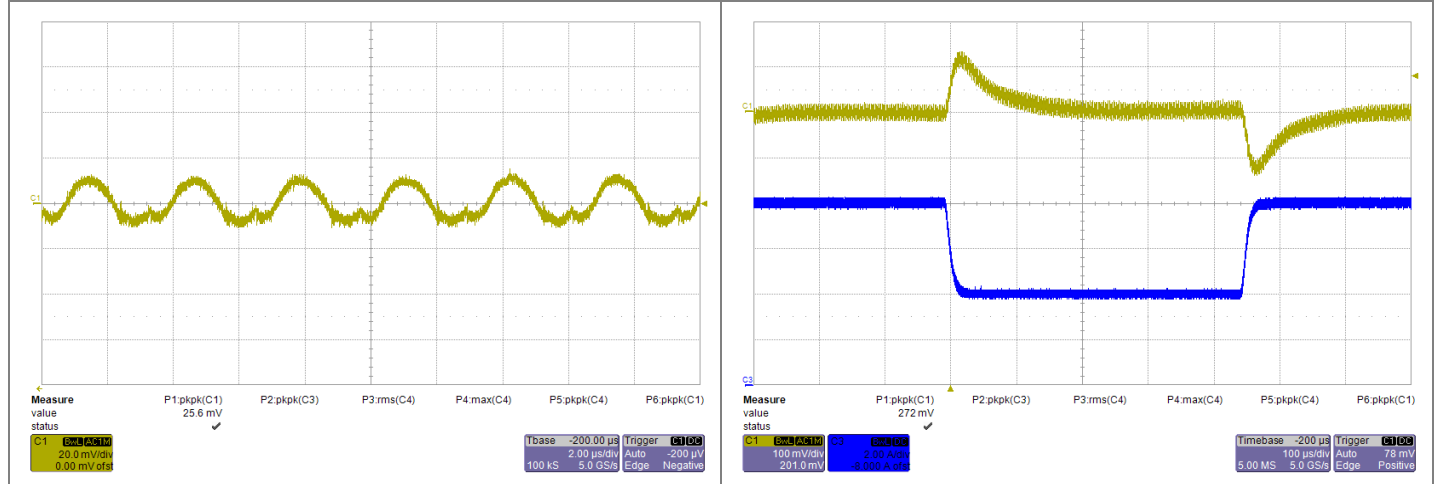

Noise $V_{IN}=12V, I_O=8A, 5\sim 20MHz$ Bandwidth

**Transient Response $V_{IN}=12V$, Step from 4A~8A~4A
Blue: Output Current Yellow: Output Ripple**

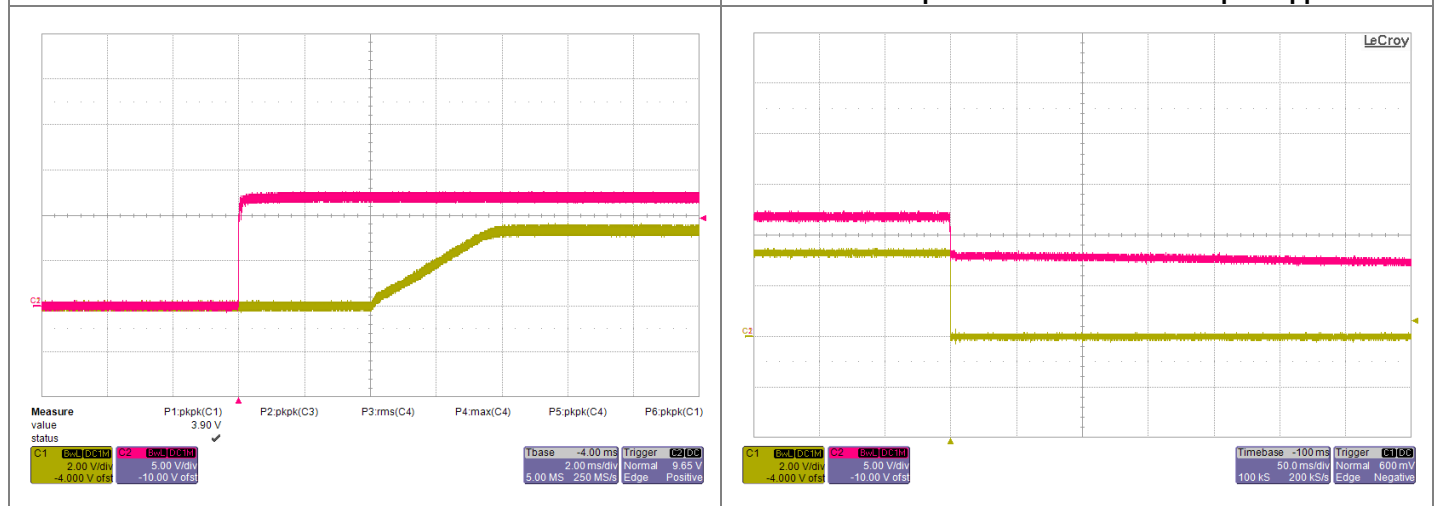

**Start-up $V_{IN}=12V, I_O=8A$
Red: Input Voltage Yellow: Output Voltage**

**Shut-down $V_{IN}=12V, I_O=8A$
Red: Input Voltage Yellow: Output Voltage**

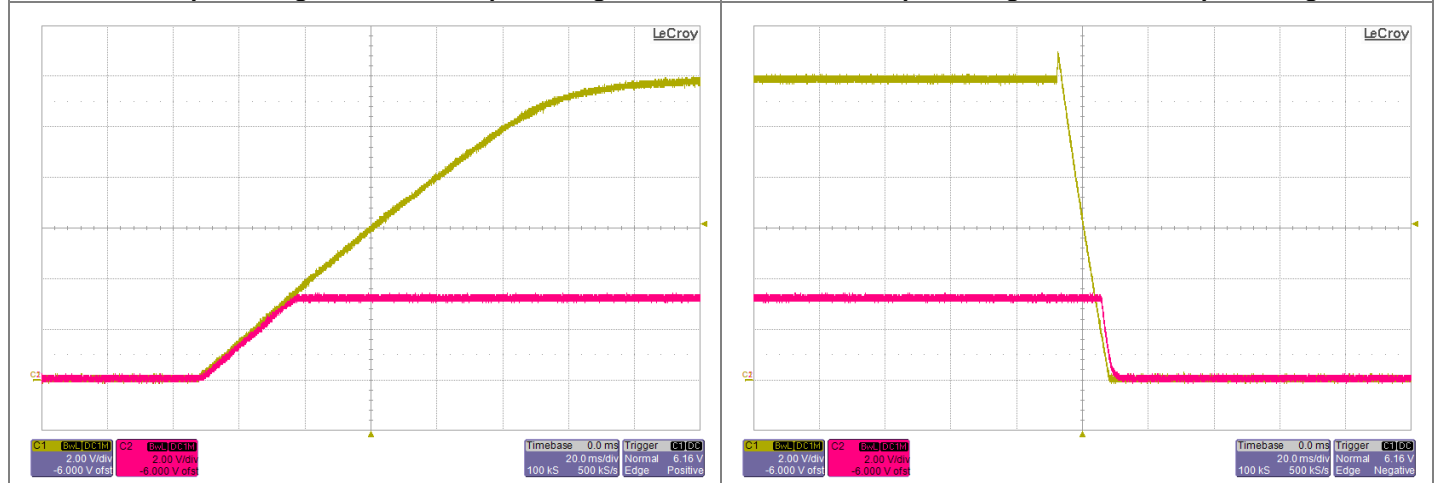

**Power Up with Auto-Track Control $V_{Track}=5.0V, I_O=8A$
Red: EasyTrack™ Control Voltage Yellow: Output Voltage**

**Power Down with Auto-Track Control $V_{Track}=5.0V, I_O=8A$
Red: EasyTrack™ Control Voltage Yellow: Output Voltage**

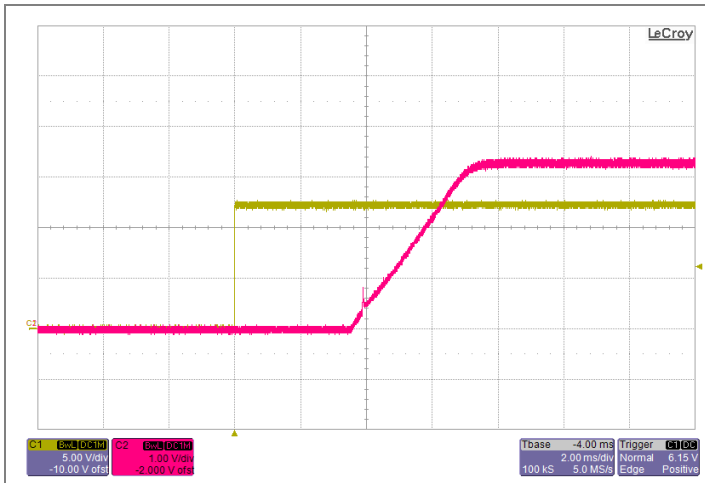

Power Up with ON/OFF Control
Red: ON/OFF Control Voltage Yellow: Output Voltage

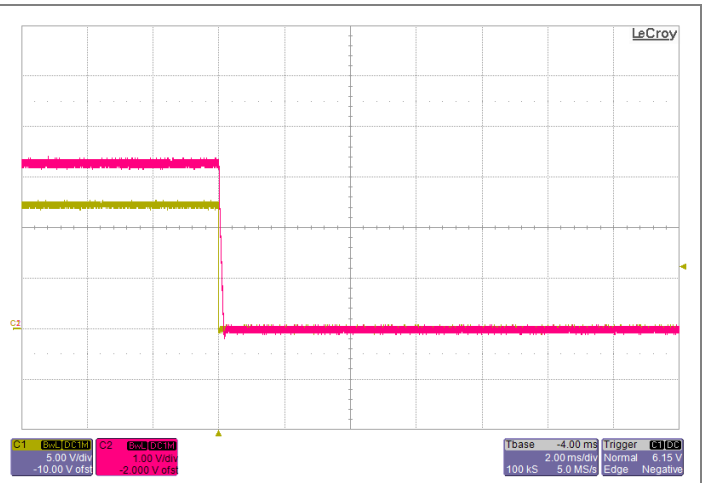

Power Down with ON/OFF Control
Red: ON/OFF Control Voltage Yellow: Output Voltage

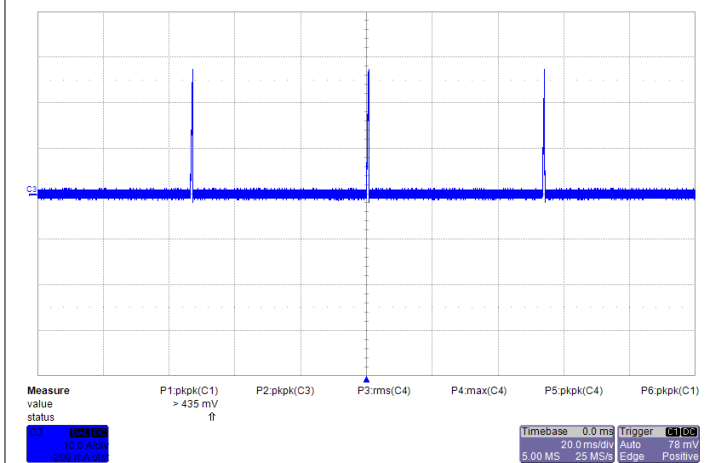

Short-Circuit Output $V_{IN}=12V$

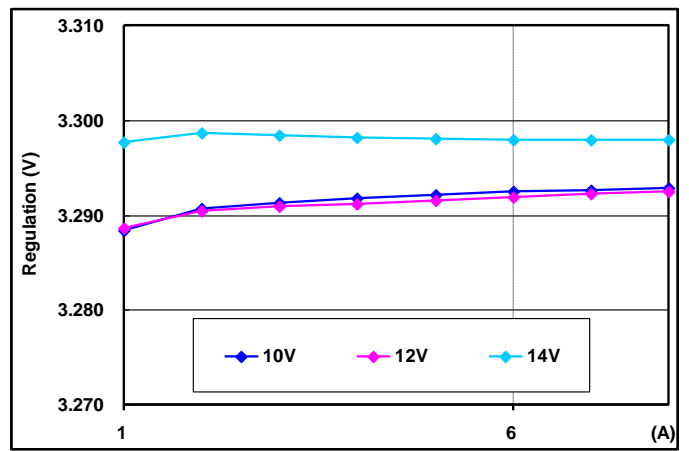

Regulation
Output voltage vs. Load Current

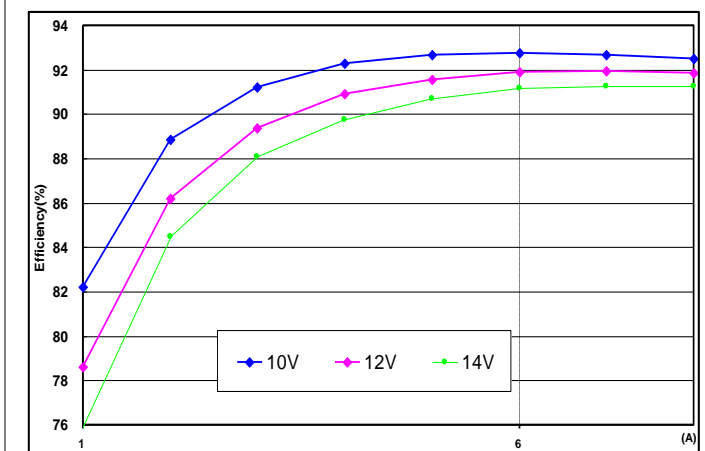

Efficiency vs. Load Current

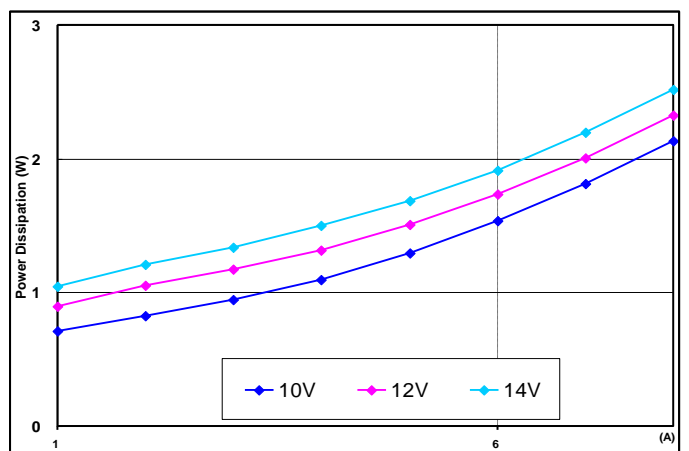

Power Dissipation vs. Load Current

Typical Characteristics – output adjusted to 5.0V

General conditions:

Input filter 22µF Ceramic + 68µF TAN+470µF AL, Output filter 22µF Ceramic + 100µF TAN

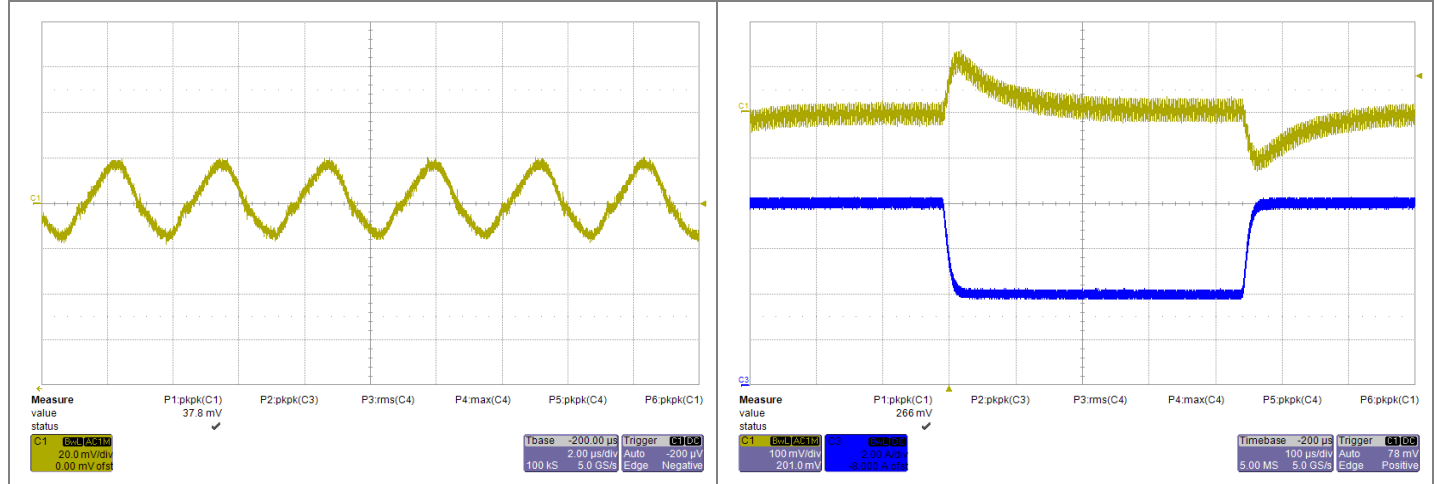

Noise $V_{IN}=12V$, $I_O=8A$, 5~20MHz Bandwidth

Transient Response $V_{IN}=12V$, Step from 4A~8A~4A
 Blue: Output Current Yellow: Output Ripple

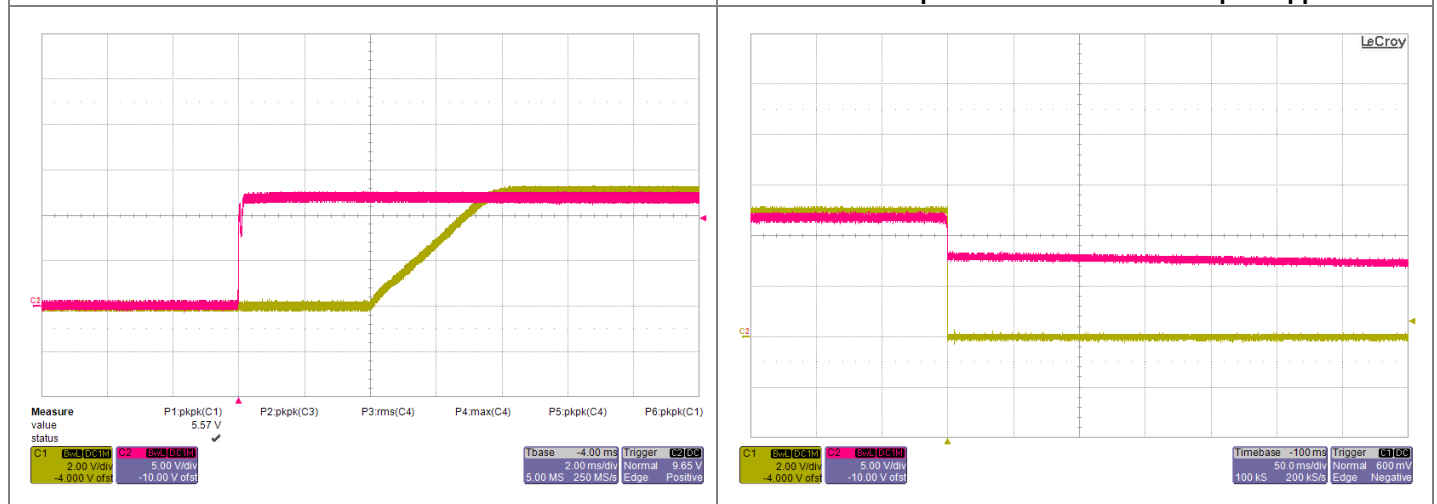

Start-up $V_{IN}=12V$, $I_O=8A$
 Red: Input Voltage Yellow: Output Voltage

Shut-down $V_{IN}=12V$, $I_O=8A$
 Red: Input Voltage Yellow: Output Voltage

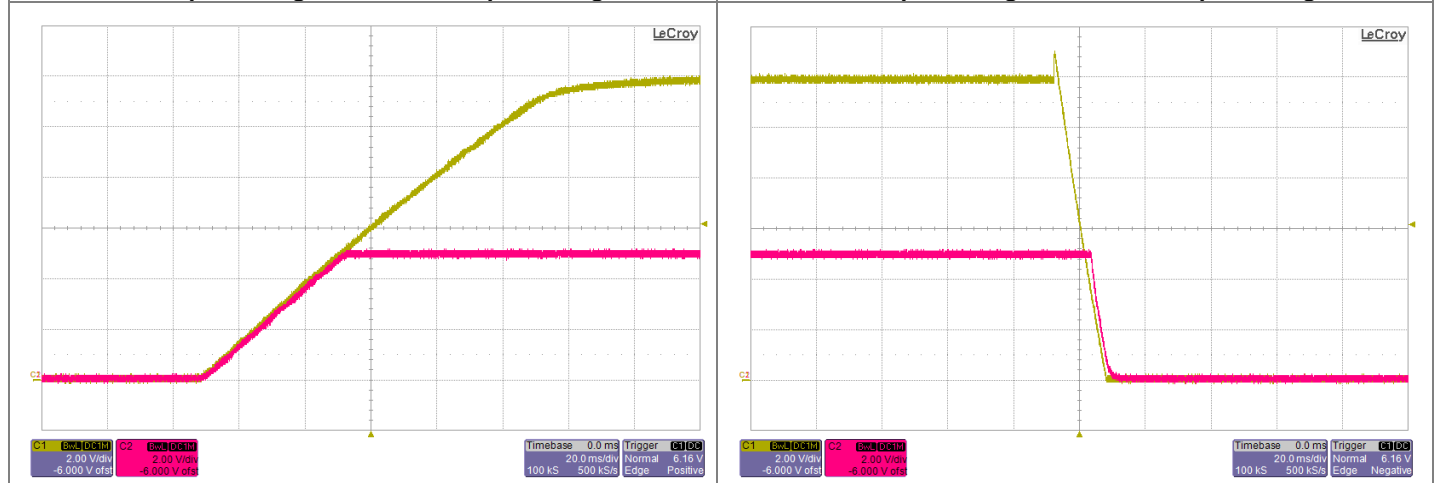

Power Up with Auto-Track Control $V_{Track}=5.0V$, $I_O=8A$
 Red: EasyTrack™ Control Voltage Yellow: Output Voltage

Power Down with Auto-Track Control $V_{Track}=5.0V$, $I_O=8A$
 Red: EasyTrack™ Control Voltage Yellow: Output Voltage

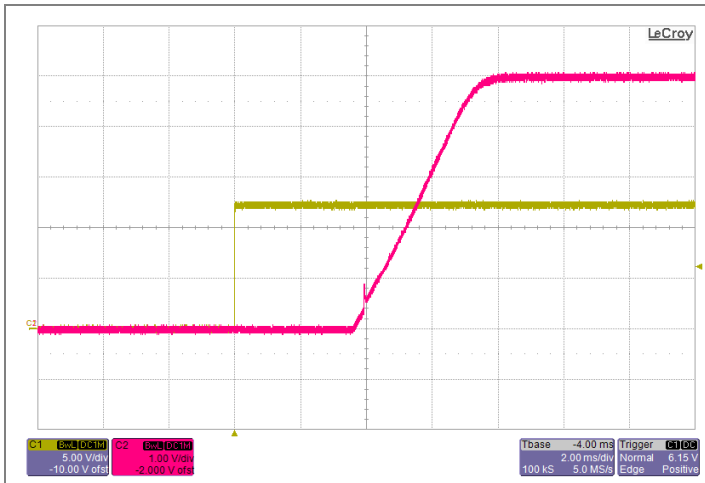

Power Up with ON/OFF Control
Red: ON/OFF Control Voltage Yellow: Output Voltage

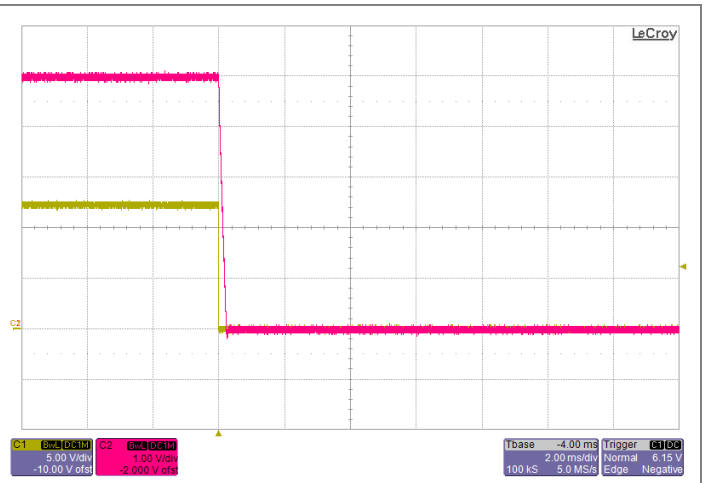

Power Down with ON/OFF Control
Red: ON/OFF Control Voltage Yellow: Output Voltage

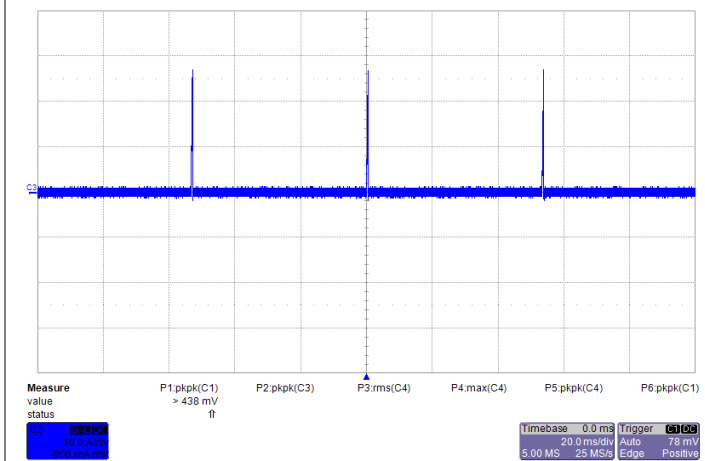

Short-Circuit Output $V_{IN}=12V$

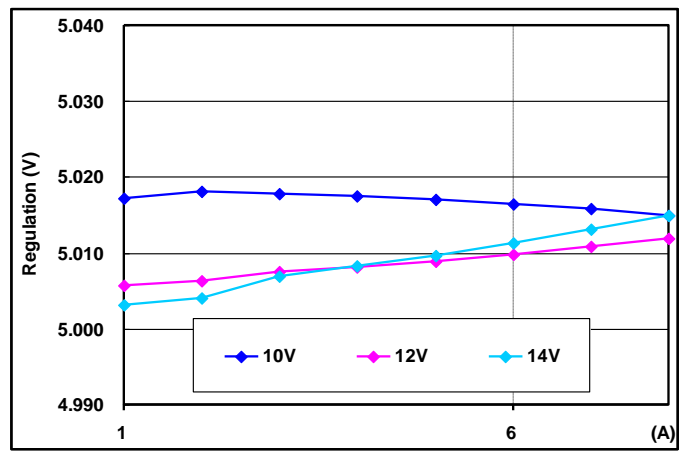

Regulation
Output voltage vs. Load Current

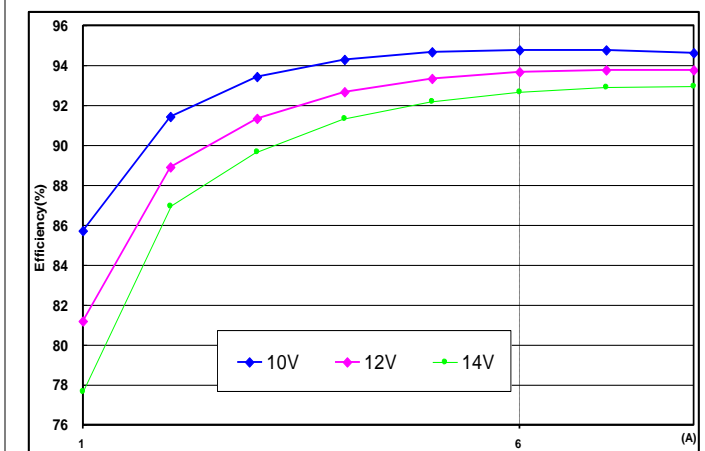

Efficiency vs. Load Current

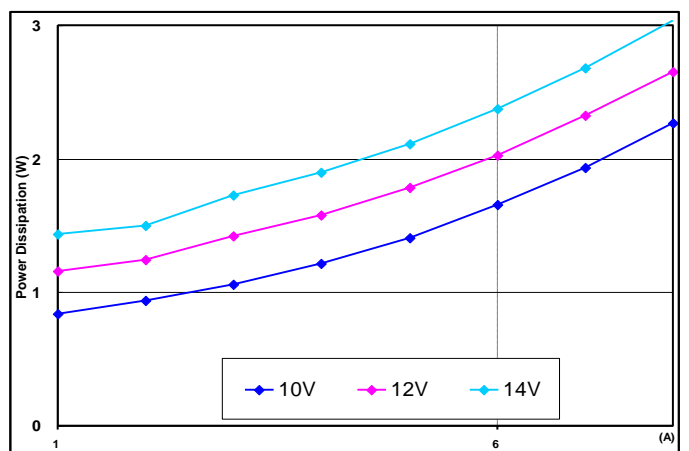

Power Dissipation vs. Load Current

Recommended Pattern for "T" suffix

Dimensions are in millimeters (inches)

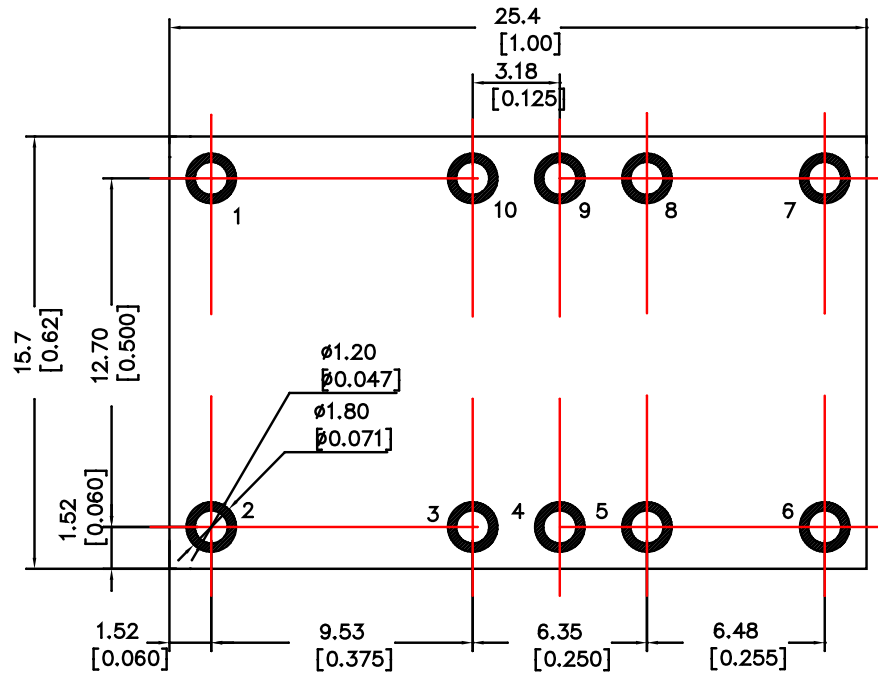

Component-side footprint

Recommended Pattern for "S" suffix

Dimensions are in millimeters (inches)

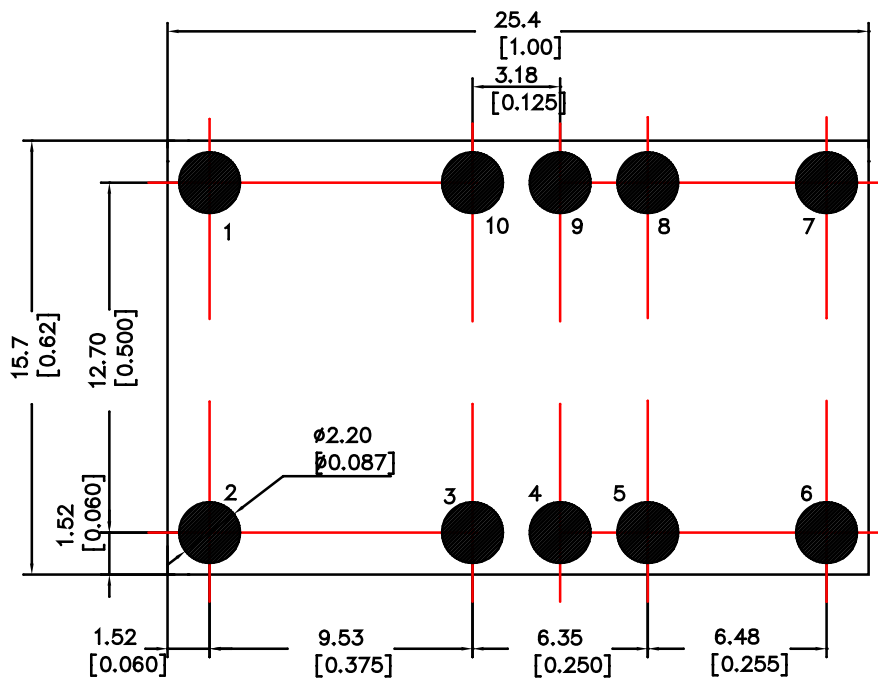

Component-side footprint

Application Notes