



FEATURES

- Wide operating voltage:
 - 42V ~ 57V
- Integrated active bridge & 802.3bt interface built-in
- Active bridge to reduce power loss
- Output Current:
 - 5V, 14A
 - 12V, 6A
 - 28V, 2.6A
- Output voltage ripple: 45 mVpp (input 48V, 5V@14A)
- High Efficiency 92% (input 48V, 5V@14A including bridge)
- Output Voltage adjust: 90% to 110% of $V_{O,SET}$
- Overcurrent/short-circuit protection
- High reliability: designed to meet 500k hour MTBF
- Minimal space on PCB:
 - 58.4 mm x 22.9 mm x 10.5 mm
 - 2.3 in x 0.9 in x 0.41 in
- No derating to +TBD°C, natural convection
- Design to meet UL/IEC/EN60950
- Operating Temperature: -40 ~ +85°C

APPLICATIONS

- IP Camera & Tilt
- Wireless Access Point
- Video surveillance
- 5G AAU

Description

The **POE MQ7804BS** series of modules are designed to extract power from a conventional twisted pair Category 5 Ethernet cable, conforming to the IEEE 802.3bt Power-over-Ethernet (PoE) standard but with 72W output power. The **MQ7804BS** series of modules embedded 2 active rectifier bridges which extremely reduce the power dissipation comparing with the traditional Schottky diodes bridges, have two pairs of power inputs pins: - VA1&2 and VB1&2 to accommodate high power PoE application with 4-pair wire power transfer.

The **MQ7804BS** signature and control circuit provides the PoE bt compatibility signature and power classification required by the Power Sourcing Equipment (PSE) before applying up to power to the port. The **MQ7804BS** can be set to class4 to class 8 by external one classification resistor to get different power class from PSE.

The high efficiency DC/DC converter operates over a wide input voltage range and provides a regulated low ripple and low noise output. The DC/DC converter also has built-in overload and short-circuit output protection.

***** Typical Application Circuit *****

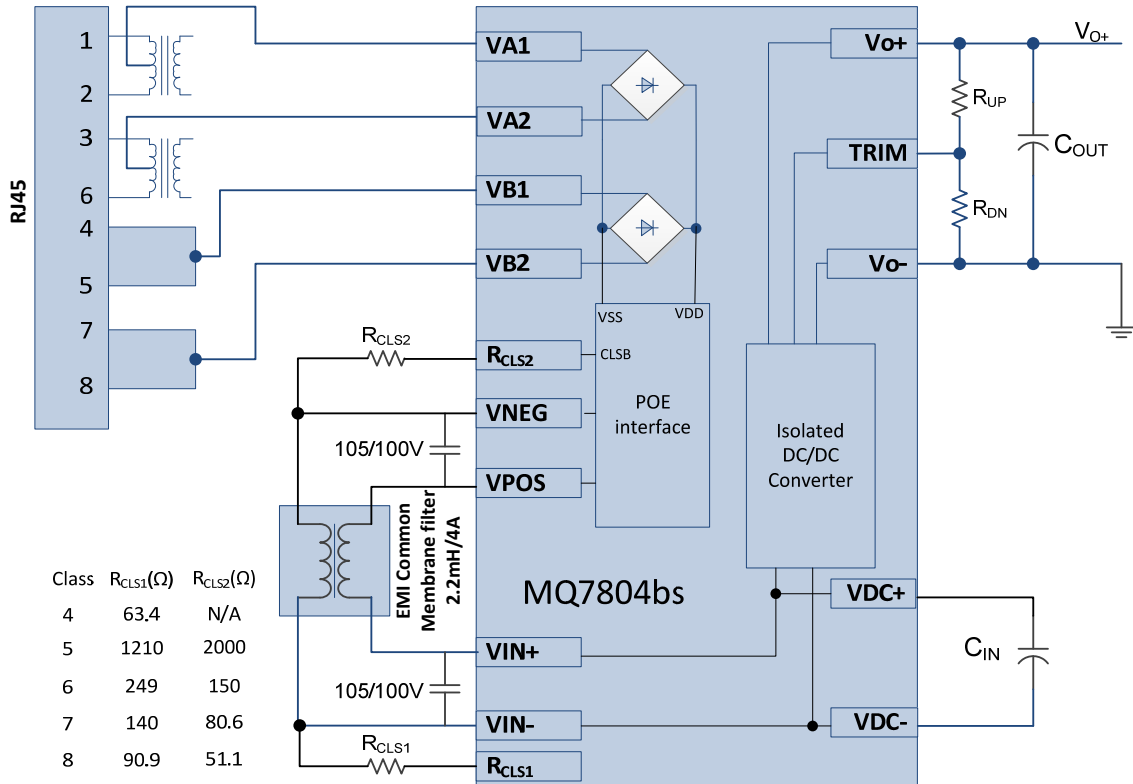

MQ7804BS application diagram

Note:

C_{IN} recommended from 47μF to 220μF AL-cap with 5~10μF ceramic cap;

Performance Specifications (at Ta=+25°C)

Model	Input V _{IN} Range (V)	Output				Efficiency (%)
		I _{OUT.MAX} (A)	V _{out} (V)	Regulation		
				Line (%)	Load (%)	
MQ7804BST050	42 ~57	14	5	0.5	0.5	92
MQ7804BST120		6.0	12	0.5	0.5	TBD
MQ7804BST280		2.6	28	0.5	0.5	TBD

Mechanical Specifications

Dimensions are in millimeters (inches)

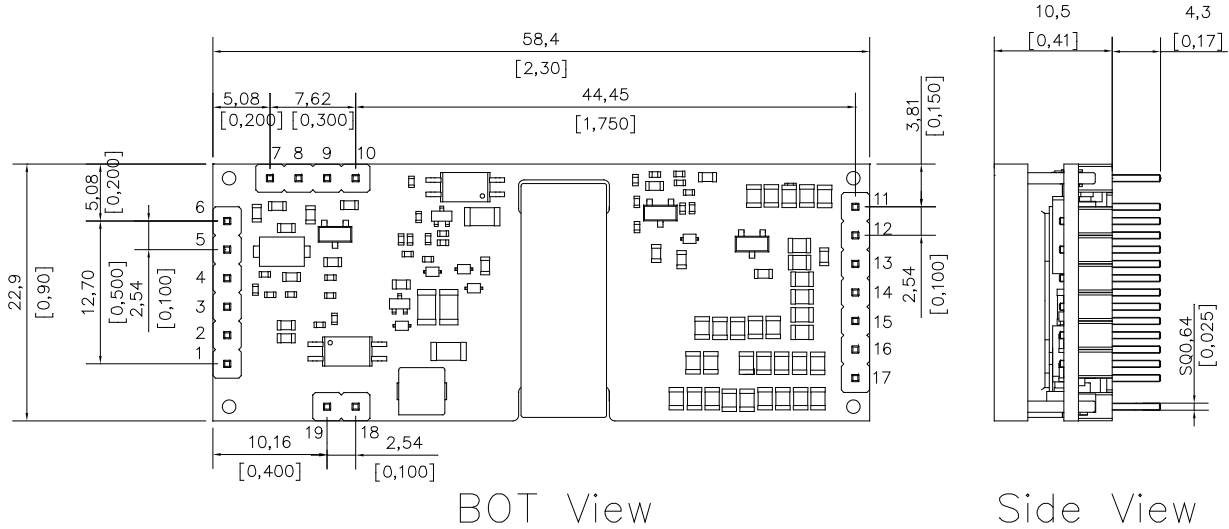

BOT View

Side View

PIN		DESCRIPTION
1	VIN+	PoE positive input
2	VIN-	PoE negative input
3	RCLS1	Classification resistor 1
4	RCLS2	Classification resistor 2
5	VNEG	Bridge negative output
6	VPOS	Bridge positive output
7	VA1	Pair from network transformer's central tap
8	VA2	
9	VB1	Pair from network transformer's central tap
10	VB2	
11、12、13	Vo-	Output negative end
14	Trim	Output Trim
15、16、17	Vo+	Output positive end
18	VDC+	DC/DC positive input end
19	VDC-	DC/DC negative input end

Ordering Information

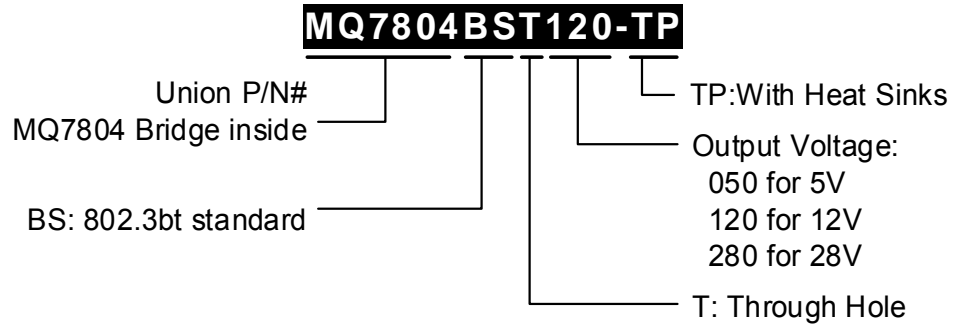

Absolute Maximum Ratings

Note: These are stress ratings. Exposure of devices to any of these conditions may adversely affect long-term reliability. Proper operation under conditions other than those listed in the Performance Specifications Table is not implied.

Parameter	Symbol	Min	Max	Unit
Operating Ambient Temperature	T _A	-40	85	°C
Storage Temperature	T _{STG}	-40	85	°C
Altitude			4000	m
I/O Isolation voltage (100% factory Hi-pot tested)			2250	V _{DC}

MQ7804BS General Specifications: (T_A=+25°C)

Note: Unless otherwise indicated, specifications apply over all operating input voltage, resistive load, and temperature conditions.

Parameter	Condition	Symbol	Min	Typ.	Max	Unit
Operating Input Voltage Range	100% Load	V _{IN}	42		57	V _{DC}
V _{IN} - Inrush current limit	(V _{DC} -) – (V _{IN} -) > 2 V, During C _{IN} charge period		275	335	395	mA
Input Current Limit	V _{IN} =V _{IN.MIN} To V _{IN.MAX}		1.3	1.5	1.9	A
Input Turn-ON Threshold	10% Max Load, input rising	V _{IN.ONTH}	40.2		41.5	V _{DC}
Input Turn-OFF Threshold	10% Max Load, input falling	V _{IN.OFFTH}	38.3		39.3	V _{DC}
Output Power	V _{IN} =V _{IN.MIN} To V _{IN.MAX}	P _o	0		72	W
Output Continuous Short-circuit Protection	V _{IN} =V _{IN.MIN} To V _{IN.MAX}		YES			
MTBF			500,000			Hours

MQ7804BST050 Electrical Specifications: (T_A=+25°C)

Parameter	Condition	Symbol	Min	Typ.	Max	Unit
Input No Load Current	V _{IN} =48V, V _o =V _{o.SET} , I _o =0, module enabled	I _{IN,NOLOAD}			26	mA
Nominal Output Voltage Set-point	V _{IN} = V _{IN.MIN} To V _{IN.MAX}			5		V
Maximum load	V _{IN} = V _{IN.MIN} To V _{IN.MAX}				14.4	A
Output Current limit	V _{IN} =48V	I _{ocp}			17.6	A
Output Voltage Set point	100% load	ΔV _o	-1		+1	%V _{o.SET}
Adjustment Range		V _{o, ADJ}	-10		10	%V _{o.SET}
Output Ripple and Noise Voltage	V _{IN} =48V I _o =10A, 5~20MHz, Measured with 0.1μF ceramic	V _{pk-pk}		45		mVpp
Transient Response	Load step from 50%~100%~50% I _{o,MAX} , di/dt=0.1A/μS			1000		mV
	Response time			200		μS
Efficiency	V _{IN} =48, 100% Load, including bridge	η		92		%
Switching Frequency		F _o		400		KHz
External Capacitive Load		C _{o,EXTERNAL}	220		2500	μF
Inrush Current	V _{IN} =55V	I _{inrush}				mA

MQ7804BST120 Electrical Specifications: ($T_A=+25^{\circ}\text{C}$)

Parameter	Condition	Symbol	Min	Typ.	Max	Unit
Input No Load Current	$V_{IN}=48\text{V}$, $V_O=V_{O,SET}$, $I_O=0$, module enabled	$I_{IN,NOLOAD}$		70		mA
Nominal Output Voltage Set-point	$V_{IN} = V_{IN,MIN}$ To $V_{IN,MAX}$			12		V
Maximum load	$V_{IN} = V_{IN,MIN}$ To $V_{IN,MAX}$				6	A
Output Voltage Set point	100% load	ΔV_O	-1		+1	% $V_{O,SET}$
Adjustment Range		$V_{O,ADJ}$	-10		10	% $V_{O,SET}$
Output Ripple and Noise Voltage	$V_{IN}=48\text{V}$ $I_O=4.2\text{A}$, 5~20MHz, Measured with 0.1 μF ceramic			120		mVpp
Transient Response	Load step from 50%~100%~50% $I_{O,MAX}$, $di/dt=0.1\text{A}/\mu\text{S}$					mV
	Response time			350		μS
Efficiency	$V_{IN}=48$, 100% Load, including bridge	η	89.5	90.5		%
	$V_{IN}=48$, 100% Load, no bridge	η	90.4	91.4		%
Switching Frequency		F_O		400		kHz
External Capacitive Load		$C_{O,EXTERNAL}$	0		2000	μF
Inrush Current	$V_{IN}=55\text{V}$	I_{inrush}		150		mA

MQ7804BST280 Electrical Specifications: ($T_A=+25^{\circ}\text{C}$)

Parameter	Condition	Symbol	Min	Typ.	Max	Unit
Input No Load Current	$V_{IN}=48\text{V}$, $V_O=V_{O,SET}$, $I_O=0$, module enabled	$I_{IN,NOLOAD}$				mA
Nominal Output Voltage Set-point	$V_{IN} = V_{IN,MIN}$ To $V_{IN,MAX}$			28		V
Maximum load	$V_{IN} = V_{IN,MIN}$ To $V_{IN,MAX}$				2.8	A
Output Voltage Set point	100% load	ΔV_O	-1		+1	% $V_{O,SET}$
Adjustment Range		$V_{O,ADJ}$	-10		10	% $V_{O,SET}$
Output Ripple and Noise Voltage	$V_{IN}=48\text{V}$ $I_O=2.1\text{A}$, 5~20MHz, Measured with 0.1 μF ceramic					mVpp
Transient Response	Load step from 50%~100%~50% $I_{O,MAX}$, $di/dt=0.1\text{A}/\mu\text{S}$					mV
	Response time					μS
Efficiency	$V_{IN}=48$, 100% Load, including bridge	η				%
	$V_{IN}=48$, 100% Load, no bridge	η				%
Switching Frequency		F_O				KHz
External Capacitive Load		$C_{O,EXTERNAL}$				μF
Inrush Current	$V_{IN}=55\text{V}$	I_{inrush}				mA

Test Configurations

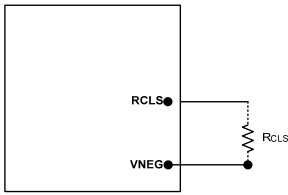

NOTE: Class Resistor Selection

Fig 1. Classification Resistors

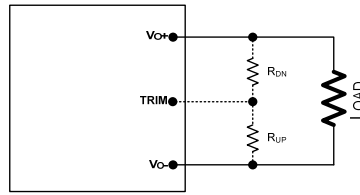

NOTE: Trimming function is allowed the output voltage set point to be adjusted from the default value in a allowed range.

Fig 2. Output Trim

Output Trim

MQ7804BS output can be trimmed up or down by connecting one resistor to output negative or positive end as **Fig 2**. Output Trim. Connecting an external resistor (R_{DN}) between the TRIM pin and the $V_{O(+)}$ (or Sense(+)) pin decreases the output voltage set point. To maintain set point accuracy, the trim resistor tolerance should be $\pm 1.0\%$. The following equation determines the required external resistor value:

$$R_{DN} = \left[\frac{(V_{O,DN} - 2.5) * 12}{V_{O,SETP} - V_{O,DN}} - 2 \right] K\Omega$$

$V_{O,SET}$ is the output default set-point voltage of the module, $V_{O,DN}$ is the desired trim-down output voltage. Connecting an external resistor (R_{UP}) between the TRIM pin and the $V_{O(-)}$ (or Sense (-)) pin increases the output voltage set point. The following equation determines the required external resistor value:

$$R_{UP} = \left(\frac{30}{V_{O,UP} - V_{O,SET}} - 2 \right) K\Omega$$

$V_{O,SET}$ is the output default set-point voltage of the module, $V_{O,UP}$ is the desired trim-up output voltage.

Over-temperature Protection

The unit isn't equipped with a thermal shutdown circuit. If the thermal reference points, T_{ref} (Thermal Pad), exceed $115^{\circ}C$ respectively, the unit may not work properly or even be permanently damaged. So sufficient cooling should be provided to help ensure reliable operation.

Classification Resistors

Connect a resistor from RCLS to V_{IN-} to program the classification current according to the IEEE 802.3bt standard. Table 1 lists the external resistor values required for each of the PD power ranges defined by IEEE802.3bt.

PD class	Power at PD(W)	$R_{CLS1}(\Omega)$	$R_{CLS2}(\Omega)$
4	25.5	63.4	N/A
5	40	1210	2000
6	51	249	150
7	62	140	80.6
8	71	90.9	51.1

Table 1. Class Resistor Selection

Current limit during startup

IEEE 802.3bt has a startup current limitation, providing compatibility between a PSE of any Type and a PD of any Type. When input voltage rises above input Turn-ON Threshold ($V_{IN,ONTH}$), the **MQ7804BS** starts charging the bulk capacitor C_{IN} under the 335mA V_{IN-} inrush current limit, which is compatible with all PSE type. Once the inrush current falls about 10% below the inrush current limit, the **MQ7804BS** internal current limit switches to the operational level, which is approximately 2.2 A, and internal DCDC converter will be started shortly.

Typical Characteristics – MQ7804BST050

General conditions:
 Input filter: 100 μ F/100V AL-Cap;
 Output filter : 220 μ F/ 68V AL-Cap+0.1 μ F/50V Ceramic Cap;

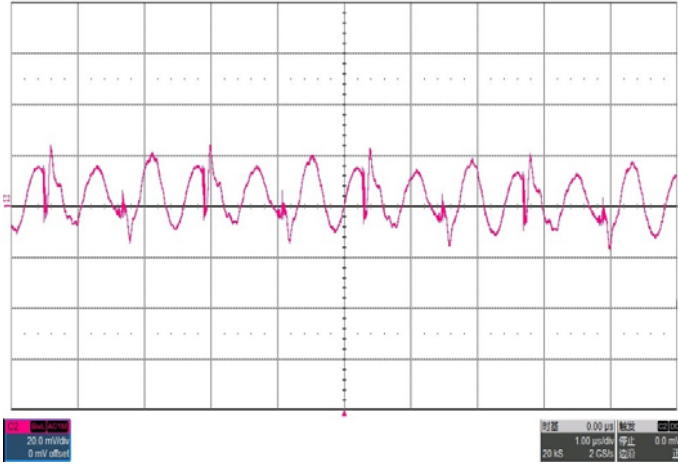

Noise & Ripple $V_{IN}=42V$, $I_O=14A$, 5~20MHz Bandwidth

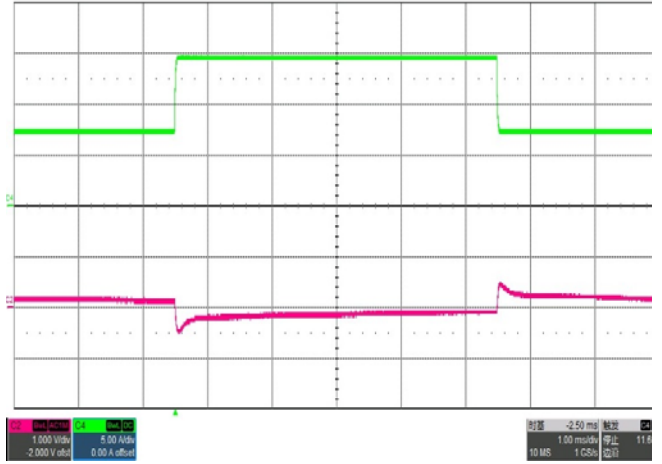

Transient Response, $V_{IN}=42V$ 7A~14A~7A load step
 CH4: Load Current CH1: Output Voltage

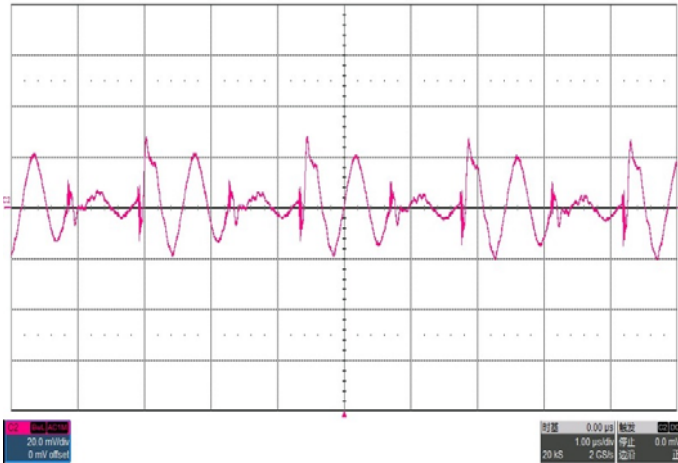

Noise & Ripple $V_{IN}=48V$, $I_O=14A$, 5~20MHz Bandwidth

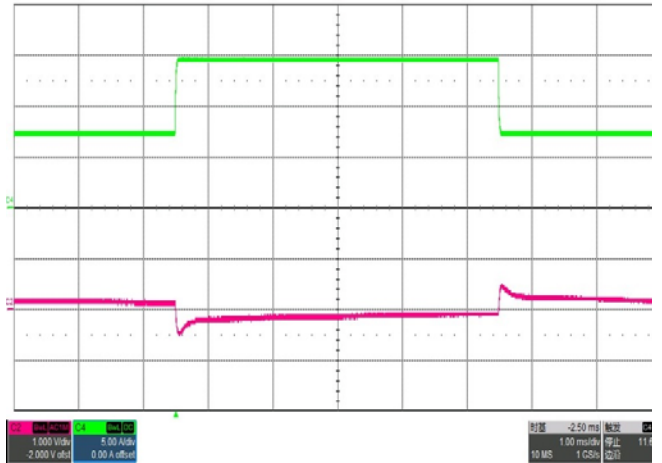

Transient Response, $V_{IN}=48V$ 7A~14A~7A load step
 CH4: Load Current CH1: Output Voltage

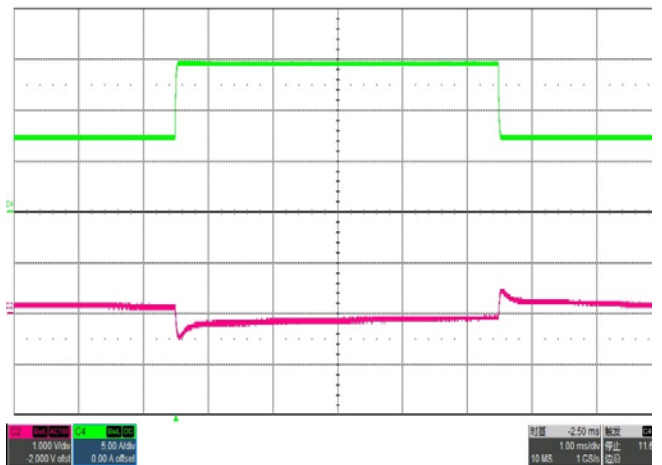
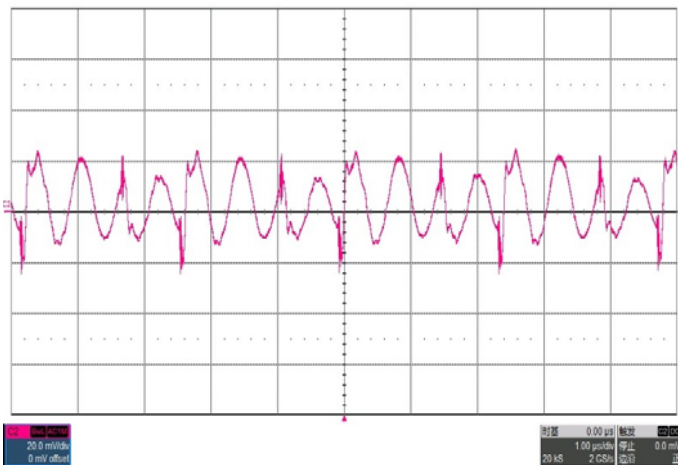

Noise & Ripple $V_{IN}=57V$, $I_O=14A$, 5~20MHz Bandwidth

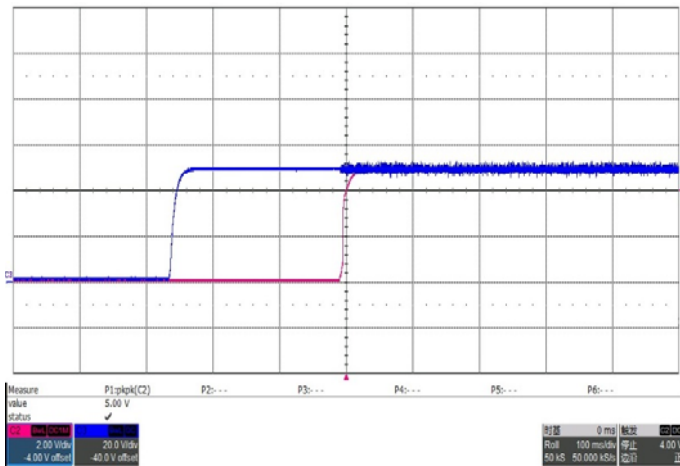

Startup $V_{IN}=48V$
 CH3: Input Voltage CH2: Output Voltage

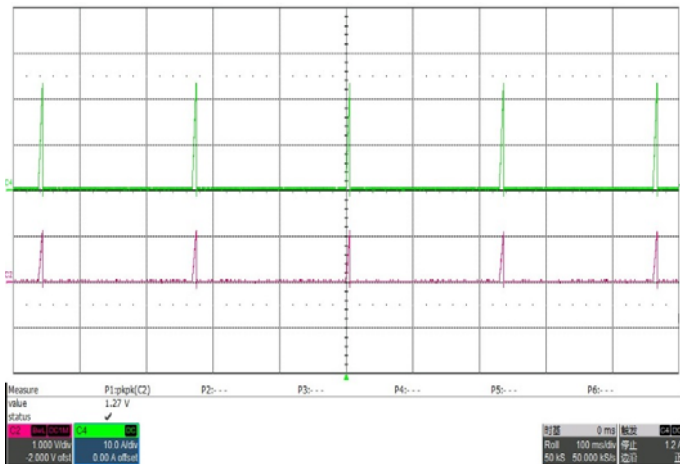

Load short protection $V_{IN}=48V$
 CH3: Input Voltage CH2: Output Voltage

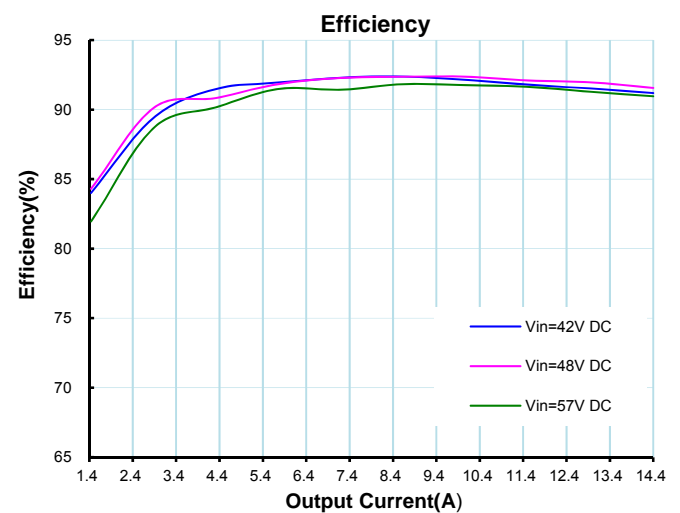

Efficiency

Transient Response, $V_{IN}=57V$ 7A~14A~7A load step
 CH4: Load Current CH1: Output Voltage

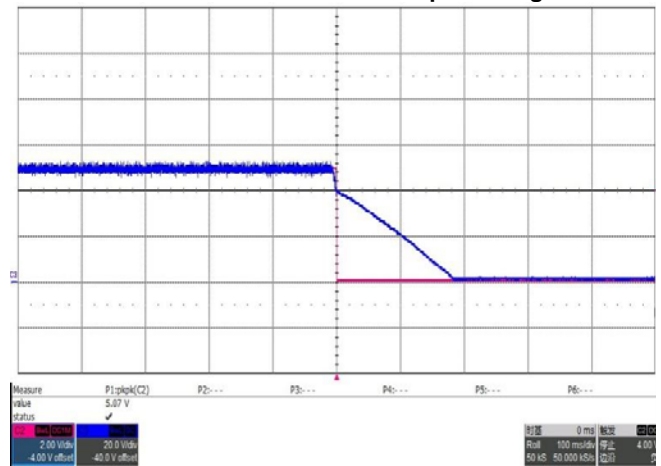

Shutdown $V_{IN}=48V$
 CH3: Input Voltage CH2: Output Voltage

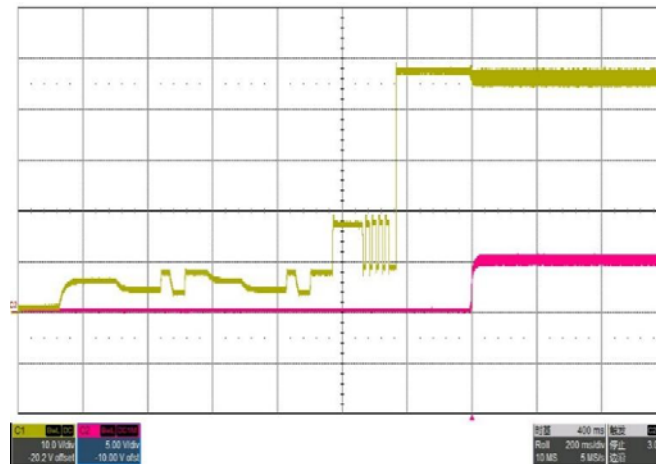

Startup from PSE
 CH1: Input Voltage CH2: Output Voltage

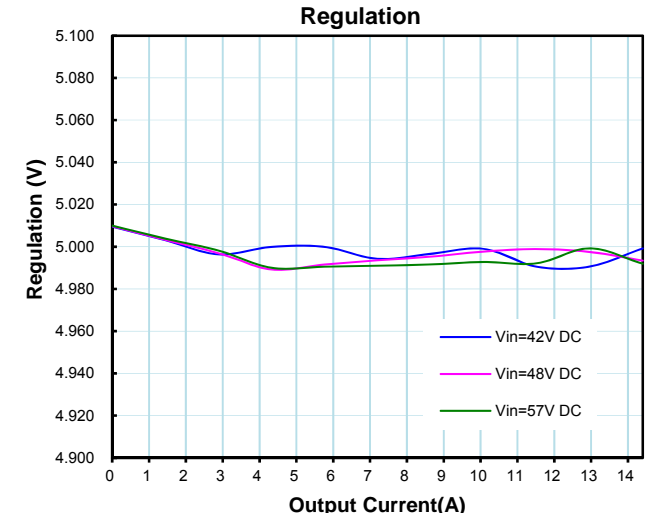

Regulation

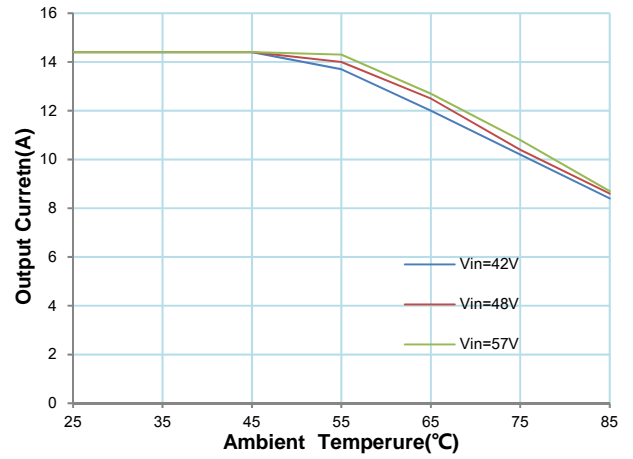
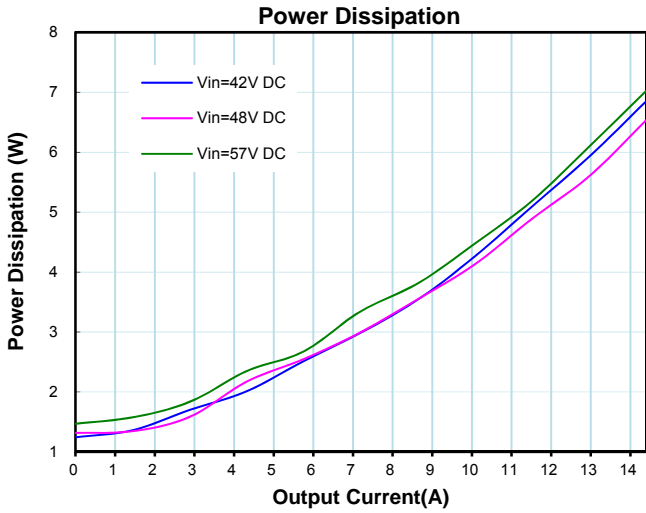

Note: "TP" Version; Test in a closed box with a size of 358mm*256mm*104mm.

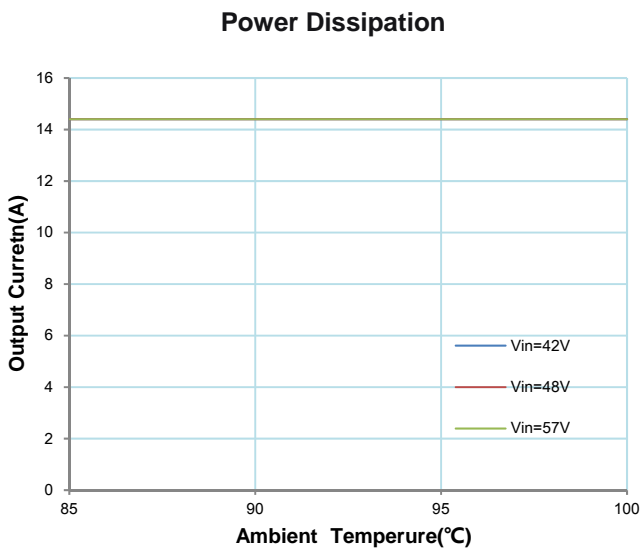

Note: "TP" Version; An aluminum plate with a size of 260mm*170mm*15mm was used in the test.

Recommended Hole Pattern

Dimensions are in millimeters (inches)

