



FEATURES

- Wide Operating Voltage: 4.5V ~14V
- Output Voltage: 0.59V ~ 6V
- Output Current Up to 6A
- Remote Control On/Off: Positive Logic (Open-Collector)
- Over current/ short circuit protection
- Over Temperature Protection
- Minimal space on PCB:
 - 0.41 in x 0.65 in x 0.33 in
 - 10.4mm x 16.5mm x 8.3 mm
- Operating temperature range: -40°C to 85°C
- UL/IEC/EN60950 compliant
- RoHS Compliant

APPLICATIONS

- Workstations, servers
- Desktop computers
- DSP applications
- Distributed power architectures
- Telecommunications equipment
- Data communications equipment
- Wireless communications equipment

Description

The **MicroTarzan™** MQ7230M Series Power Modules are non-isolated dc-dc converters that operate over a wide input voltage range of 4.5Vdc to 14Vdc and provide a precisely (2%) regulated dc output voltage programmable from 0.59 Vdc to 6Vdc via external resistor. Such a module is suitable to application with 5V or 12V power supply bus. The MQ7230M have a maximum output current of 6A respectively, with a typical full-load efficiency of over 94% at 5Vdc output voltage. The modules are in industry standard through-hole pin-out. Standard features include remote on/off with positive logic and output voltage adjustment, over-current protection, over-temperature protection.

***** **Typical Application Circuit** *****

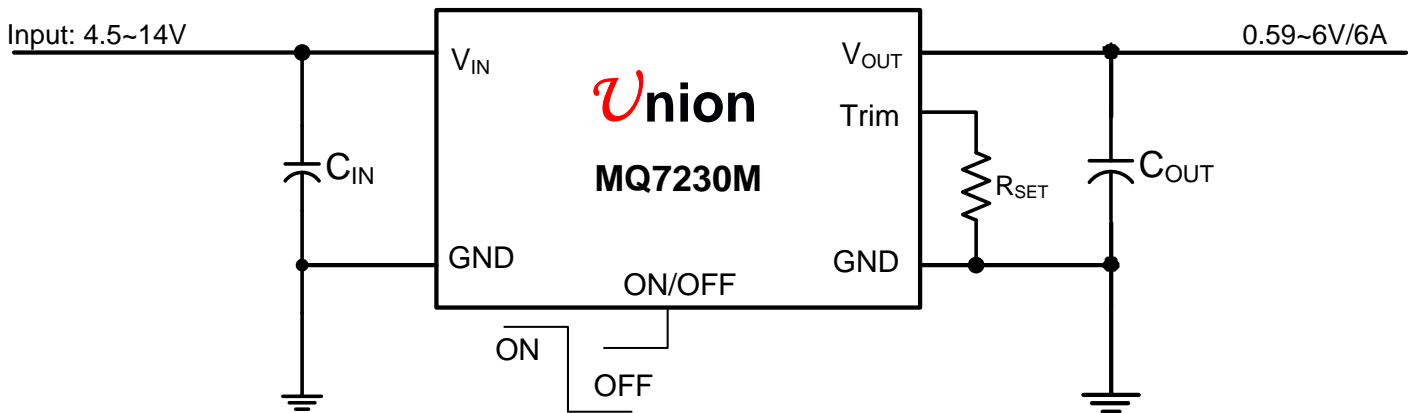

Performance Specifications (at T_A=+25°C)

| Model | Pin Out | Number of Pins | Input V _{IN} Range (V) | Output | | | | Efficiency (%) |
|---------------|--------------|----------------|---------------------------------|----------------------|----------------|------------|----------|----------------|
| | | | | I _{OUT} (A) | Trim Range (V) | Regulation | | |
| | | | | | | Line (%) | Load (%) | |
| MQ7230MT19999 | Through Hole | 5 | 4.5 ~ 14 | 6 | 0.59 ~ 6 | 1 | 1 | 95 |

Mechanical Specifications

Dimensions are in mm (inches)

Tolerances: x.x mm±0.5mm (x.xx in ±0.02 in); x.xx mm±0.25mm (x.xxx in ±0.01 in)

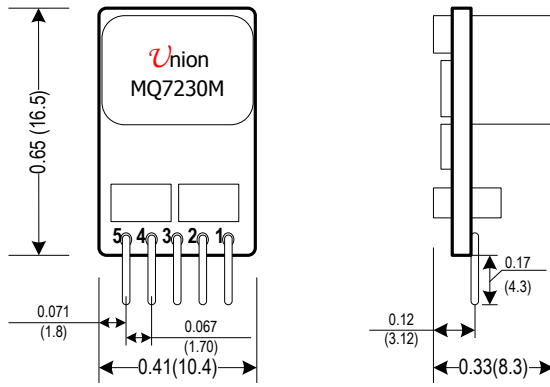

| PIN | Description |
|-----|-------------------------|
| 1 | ON/OFF |
| 2 | V _{in} , input |
| 3 | GND |
| 4 | V _o , output |
| 5 | Trim |

Ordering Information

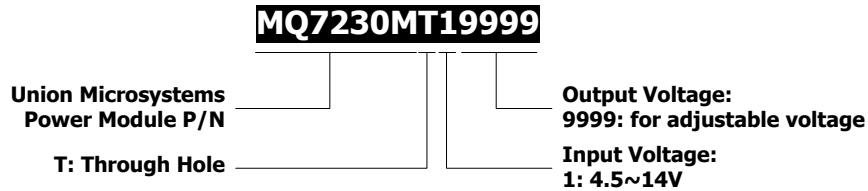

For example:

MQ7230MT19999 means MQ7230M in Trough Hole Pin-out, input voltage 4.5~14V, output voltage adjustable.

MQ7230MT10150 means MQ7230M in Trough Hole Pin-out, input voltage 4.5~14V, output voltage 1.5V.

Absolute Maximum Ratings

Note: These are stress ratings. Exposure of devices to any of these conditions may adversely affect long-term reliability. Proper operation under conditions other than those listed in the Performance Specifications Table is not implied.

| Parameter | Symbol | Min | Max | Unit |
|---------------------|-----------|------|-----|------|
| Input Voltage | V_{IN} | -0.3 | 16 | V |
| Storage Temperature | T_{STG} | -40 | 125 | °C |

MQ7230M Electrical Specifications: ($T_A=+25^\circ\text{C}$)

| Parameter | Condition | Symbol | Min | Typ | Max | Unit |
|---------------------------------|--|--------------|-----|-----|-----|---------------|
| Input Voltage Range | | V_{IN} | 4.5 | | 14 | V |
| Output Current | | I_o | 0 | | 6 | A |
| Output Voltage Set point | 100% load | ΔV_o | -2 | | +2 | % |
| Temperature Regulation | $T_A = T_{A,MIN}$ To $T_{A,MAX}$ | - | | 0.4 | | % $V_{O,SET}$ |
| Line Regulation | See each output's corresponding character figure | | | | | |
| Load Regulation | | | | | | |
| Output Ripple and Noise Voltage | | | | | | |
| Transient Response | $I_o=6A, 0\sim 20\text{MHz}$ | | | | | |

General Specifications

| Parameter | Condition | Symbol | Min | Typ | Max | Unit |
|--|--|--|-----|-----|-----|---------------|
| Maximum Capacitive Load | 6A resistive load + Aluminum capacitor | | | TBD | | μF |
| | 6A resistive load +Sanyo POSCAP | | | TBD | | |
| Overcurrent Protection | | | 12 | | 20 | A |
| Output short-circuit current (average) | All | | | | 3 | A |
| Under Voltage Lockout Trip Level | Rising and falling V_{IN} , 3% hysteresis | | | 4.3 | | V |
| Start-up Time | 6A resistive load, no external output capacitors | | | 2 | | mS |
| Switching Frequency | | F_o | | 600 | | kHz |
| Operating Temperature | Natural convection | | -40 | | 85 | °C |
| Vibration | 3 Axes, 5 Min Each | 10~55Hz, 0.35mm, 5g | | | | |
| | 3 Axes, 6 Times Each | Peak Deviation 300g, Settling Time 6mS | | | | |
| MTBF | | 5,000,000 | | | | Hour |

Test Configurations

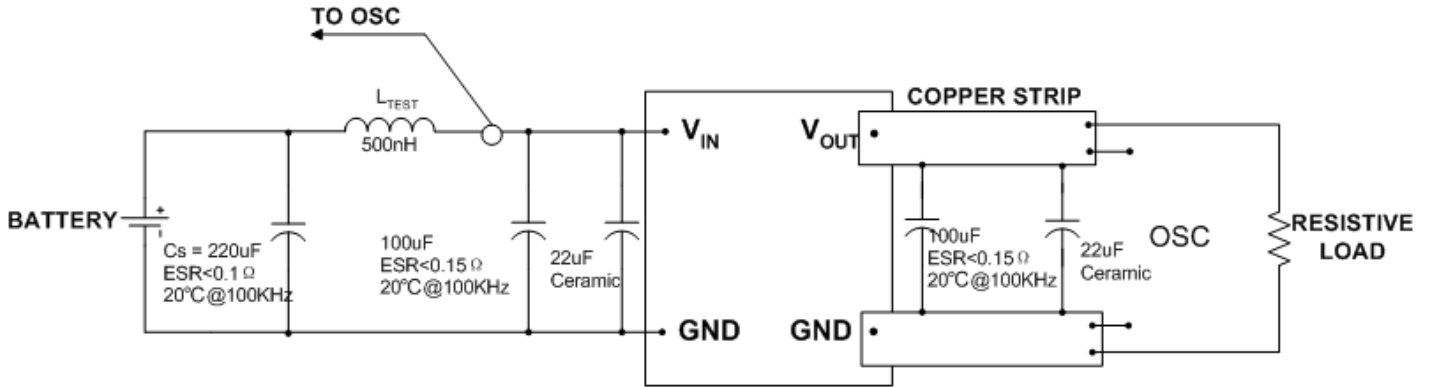

Test setup for input noise, output noise and ripple

Note:

Output noise is measured with 0.1µ F ceramic capacitor connected at the output. OSC measurement should be made using a BNC socket. Position the load between 50mm and 75mm (2in. and 3in) from the tested module.

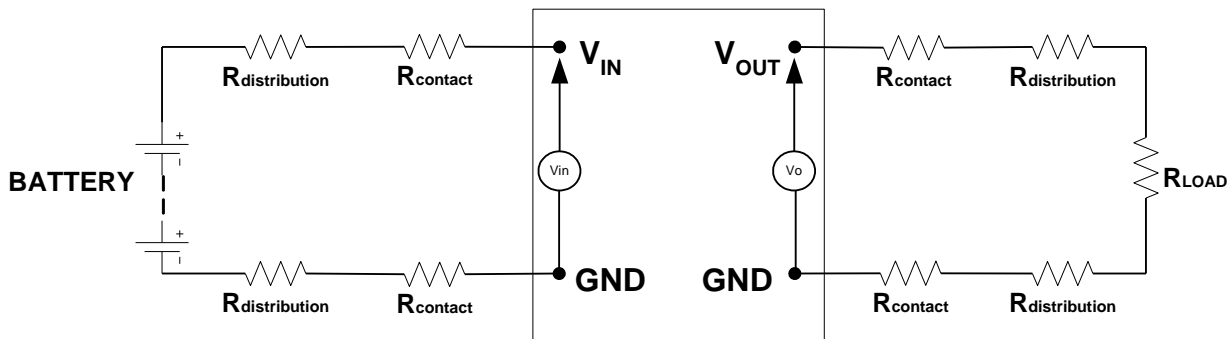

Test setup for efficiency

Note:

All voltage measurements must be taken at the module's terminals, as shown above. If sockets are needed, Kelvin connections are required at the module terminals to avoid measurement errors due to socket contact resistance.

Technical Notes

Input Voltage Range

The MQ7230M Series can be used in a wide variety of applications, esp. most of unregulated 12V intermediate power supply bus system. Its wide input voltage ranges can tolerate worst voltage drop from cheap isolated Brick-type Bus-converter, so it reduces total system cost on power supply.

Return Current Paths

The MQ7230M Series is non-isolated DC/DC converters. To the extent possible with the intent of minimizing ground loops, input and output return current should be directed through pin GND as short as possible.

I/O Filtering

All the specifications of the MQ7230M Series are tested with specified output capacitors. However, certain input capacitors are necessary to improve the power modules' operating conditions and to reduce the ac impedance. For example, under some conditions, the power modules can't normally start up when fully loaded due to the high ac-impedance input source. External input capacitors serve primarily as energy-storage devices. They should be added close to the input pins of the MQ7230M and selected

for bulk capacitance (at appropriate frequencies), low ESR, and high rms-ripple-current ratings. All external capacitors should have appropriate voltage ratings. To reduce the amount of ripple current fed back to the input supply (input reflected-ripple current), an external L-C filter can be added with the inductance as close to the power module as possible.

MQ7230M's output ripple and transient response can be improved with the increasing output capacitance. When using output capacitors, take care that the total output capacitance does not exceed MQ7230M's Maximum Capacitive Load to avoid issuing the module's over-current protection mechanism in the start-up procedure.

When an external L-C filter is added to reduce ripple on load, for best results, the filter components should be mounted close to the load circuit rather than the power module.

When testing the relationship between external capacitors and output voltage noise, the oscilloscope's probe should be applied to the module's end directly with scope probe ground less than 10mm in length.

Input Fusing

The MQ7230M Series is not internally fused. Certain applications and/or safety agencies may require the installation of fuses at the inputs of power conversion components. The selection of the fuses should conform to the following:

1. The fuse value should be fast-blow 8.5A fuses..
2. Both input traces must be capable of carrying a current of 1.5 times the value of the fuse without opening.

Safety Considerations

MQ7230M's are non-isolated DC/DC converters. In general, all DC-DC's must be installed in compliance with relevant safety-agency specifications (usually UL/IEC/EN60950). In particular, for a non-isolated converter's output voltage to meet SELV (safety extra low voltage) requirements, its input must be SELV compliant. If the output needs to be ELV (extra low voltage), the input must be ELV.

Remote Sense

MQ7230M Power Modules with suffix "S" offer a positive output sense function on pin SENSE. The sense function enables point-of-use regulation for overcoming moderate IR drops in conductors and/or cabling. The sense line carries very little current and consequently requires a minimal cross-sectional-area conductor. As such, it is not a low-impedance point and must be treated with care in layout and cabling. Sense lines should be run adjacent to signals (preferably ground). If the remote sense is not needed the sense pin should be left open or connected to V_{OUT} directly.

Use of trim and sense functions can cause the output voltage to increase, thereby increasing output power beyond the MQ7230M's specified rating. Therefore:

$$V_{OUT} \text{ (at pins)} \times I_{OUT} \leq P \text{ (rated output power)}$$

ON/OFF Control

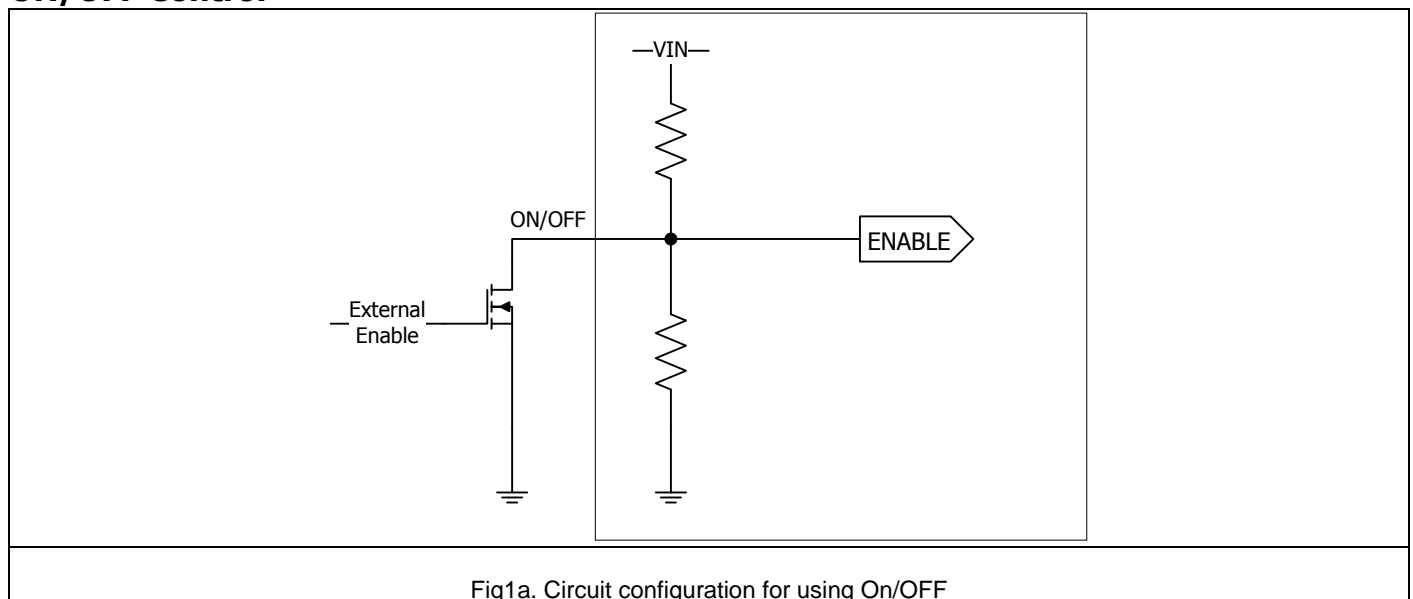

Fig1a. Circuit configuration for using On/Off

The circuit configuration for using ON/OFF pin is shown in Fig1, the On/Off pin is an open collector/drain logic input signal ($V_{on/off}$) that is referenced to ground. Refer to Fig1, when External Enable is logic "0", the ON/OFF pin will be in High and module is ON; when External Enable is logic "1", the ON/OFF pin will be in low and module is OFF.

The regulator will run in normal operation when the ON/OFF pin is left open.

Output Overvoltage Protection

MQ7230M Series products do not incorporate output over voltage protection. If the operating circuit requires protection against abnormal output voltage, voltage-limiting circuitry must be provided external to the power module.

Output Overcurrent Protection (OCP)

MQ7230M incorporates overcurrent and short circuit protection. If the load current exceeds the overcurrent protection setpoint, the MQ7230M's internal overcurrent-protection circuitry immediately turns off the module, which then goes into Hiccup mode. The unit operates normally once the output current is brought back into its specified range. The typical average output current during hiccup is less than 3A.

Caution: Be careful never to operate MQ7230M in a “heavy overload” condition that is between the rated output current and the overcurrent protection setpoint. This can cause permanent damage to the components.

Output Voltage Trimming

MQ7230M's output voltage can be trimmed in certain ranges. See Figure 3 for the 2 programming methods. See Performance Specifications for allowable trim ranges in detail. Also customized products are offered.

Trim with external resistor (Fig3a), the equation as below:

$$R_{TRIM} = \frac{1.182}{V_o - 0.591} \text{ k}\Omega$$

Resistor values are in Ω ; V_o is desired output voltage.

For examples, to trim output to 1.5V, then

$$R_{TRIM} = \frac{1.182}{V_o - 0.591} \text{ k}\Omega = 1.3\text{k}\Omega$$

So, $R_{TRIM} = 1.3\text{k}\Omega$

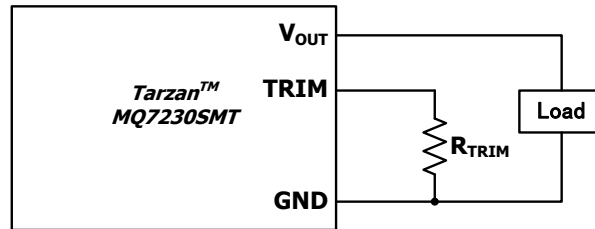

Fig3. Circuit configuration for programming output voltage using external resistor

For most common voltages, the required Trim resistors are as Table 1.

Table 1, the required trim resistors R_{TRIM} for most common voltages

| Desired Voltages (V) | R_{TRIM} (k Ω) |
|----------------------|--------------------------|
| 0.59 | Open |
| 1.0 | 2.89 |
| 1.2 | 1.941 |
| 1.5 | 1.3 |
| 1.8 | 0.978 |
| 2.5 | 0.619 |
| 3.3 | 0.436 |
| 5.0 | 0.268 |
| 6.0 | 0.219 |

Typical Characteristics – output adjusted to 0.59V

General conditions:

Input filter: 150µF TAN (150mΩ ESR), Output filter: 100µF TAN (150mΩ ESR)

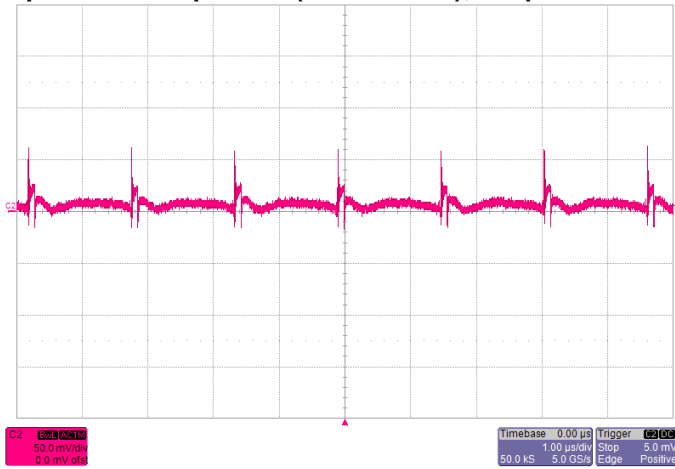

Noise $V_{IN}=12V$, $I_O=6A$, 5~20MHz Bandwidth

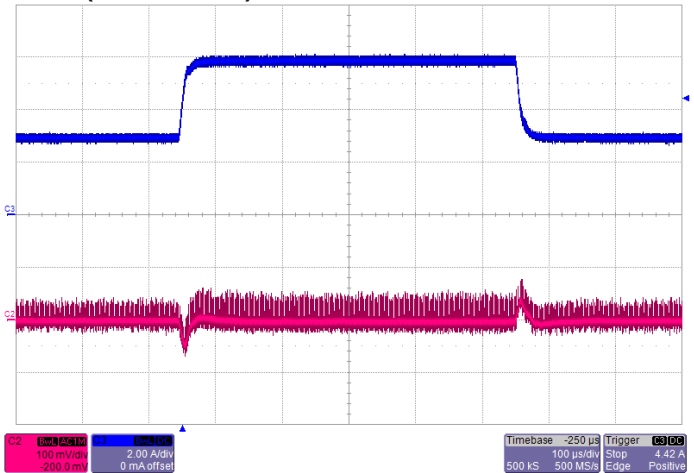

Transient Response $V_{IN}=12V$, Step from 3A~6A~3A
(C2: Output,C3: Load current)

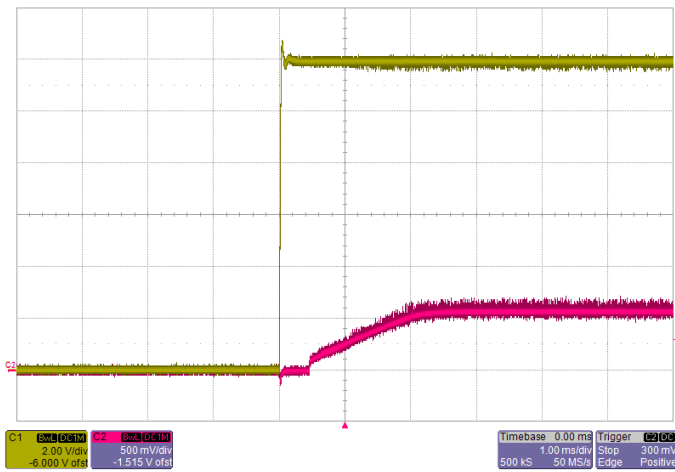

Start-up $V_{IN}=12V$, $I_O=6A$
(C2: Output,C1: Input)

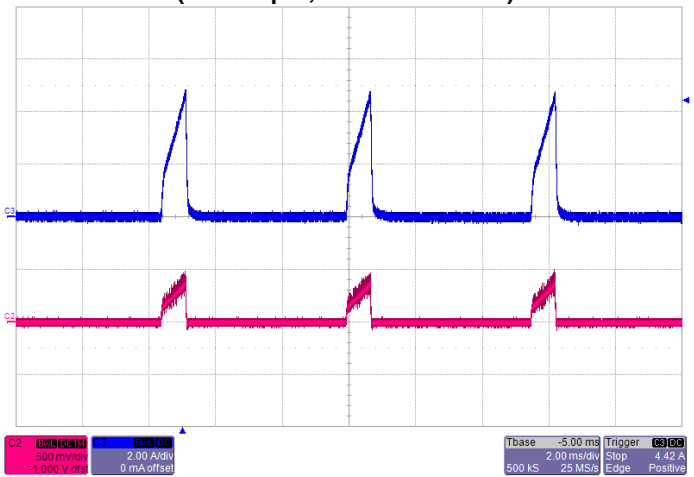

Short-Circuit Output $V_{IN}=12V$
(C2: Output voltage,C3: output current)

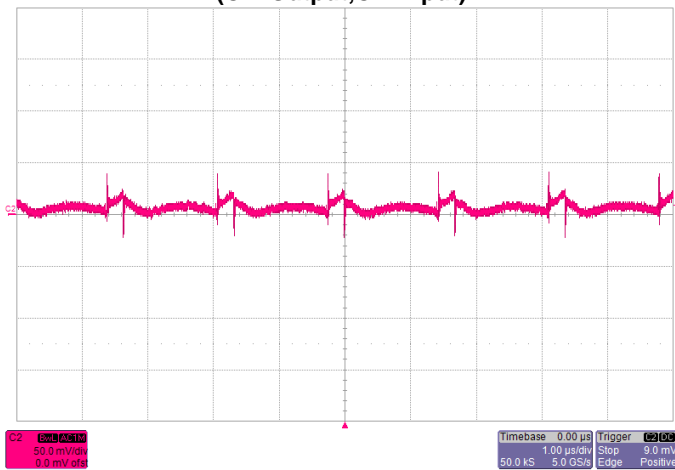

Noise $V_{IN}=5V$, $I_O=6A$, 5~20MHz Bandwidth

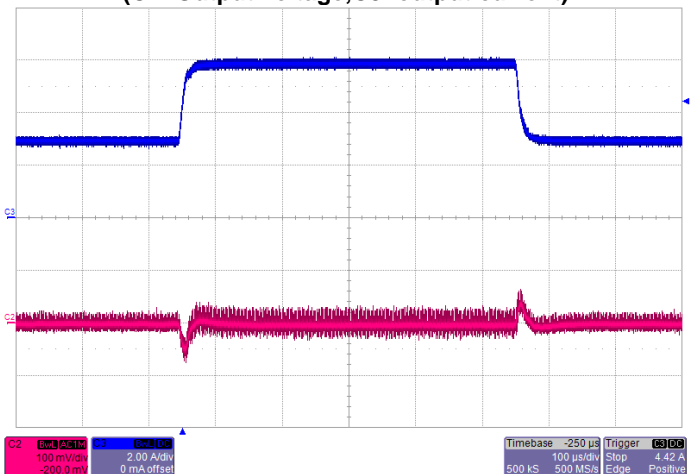

Transient Response $V_{IN}=5V$, Step from 3A~6A~3A
(C2: Output,C3: Load current)

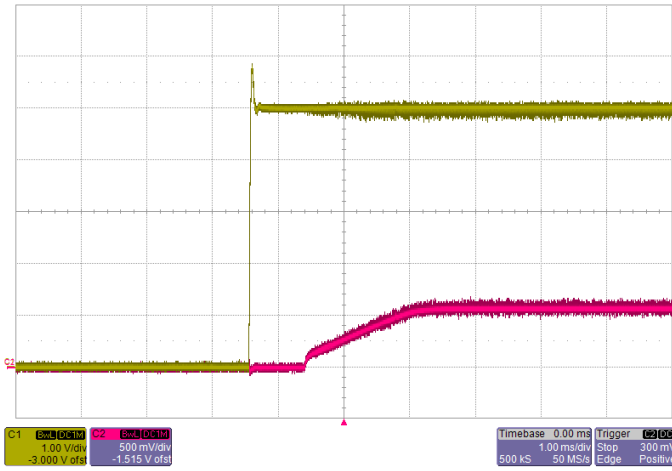

Start-up $V_{IN}=5V$, $I_o=6A$
(C2: Output,C1: Input)

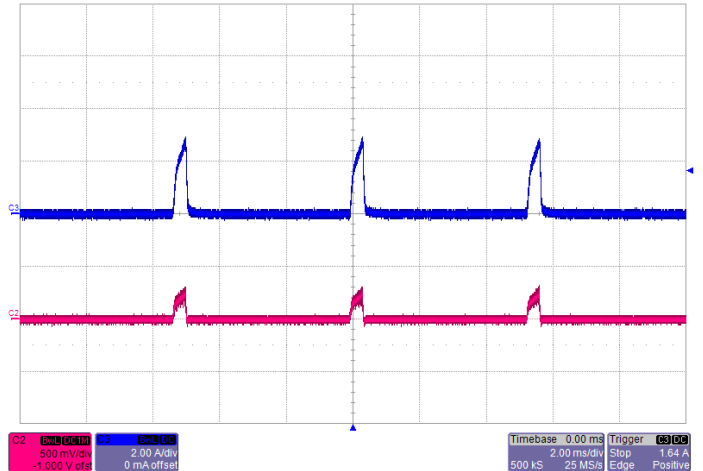

Short-Circuit Output $V_{IN}=5V$
(C2: Output voltage,C3: output current)

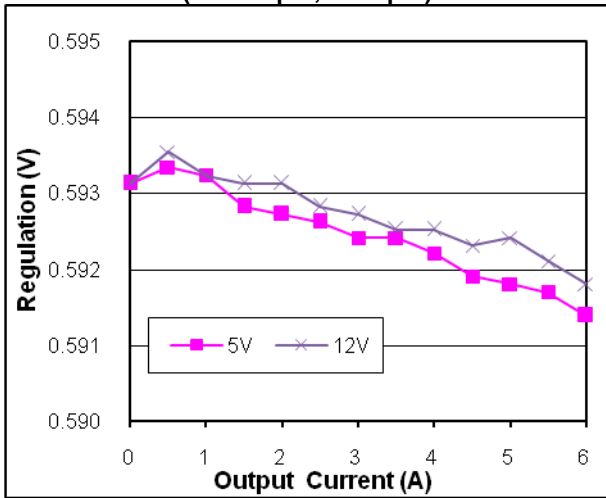

Output voltage vs. Load Current

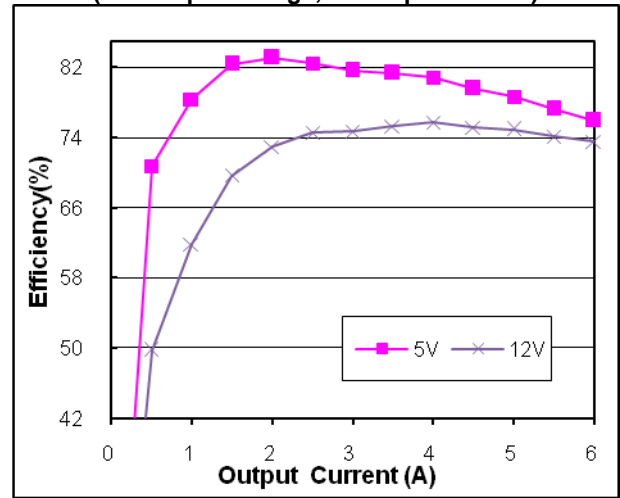

TBD

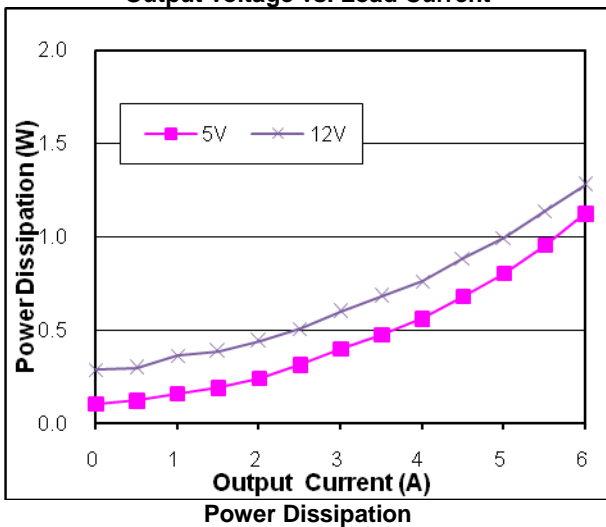

Output Current Derating (Load Current vs. Ambient Temperature (T_{REF} , See Page 6)), $V_{IN}=12V$,

Typical Characteristics – output adjusted to 1V

General conditions:

Input filter: 150µF TAN (150mΩ ESR), Output filter: 100µF TAN (150mΩ ESR)

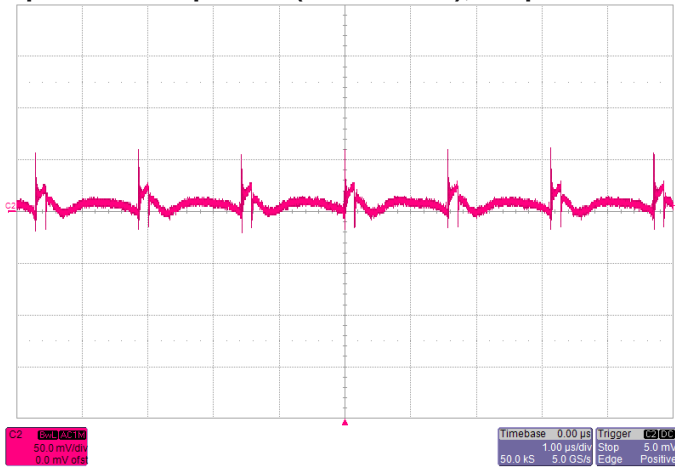

Noise $V_{IN}=12V$, $I_O=6A$, 5~20MHz Bandwidth

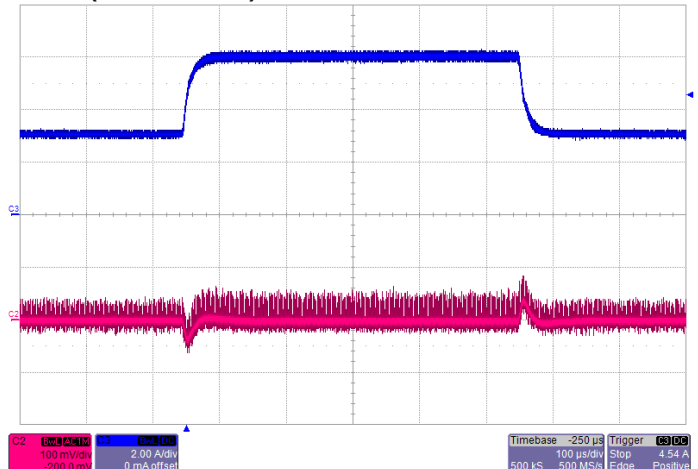

Transient Response $V_{IN}=12V$, Step from 3A~6A~3A
(C2: Output,C3: Load current)

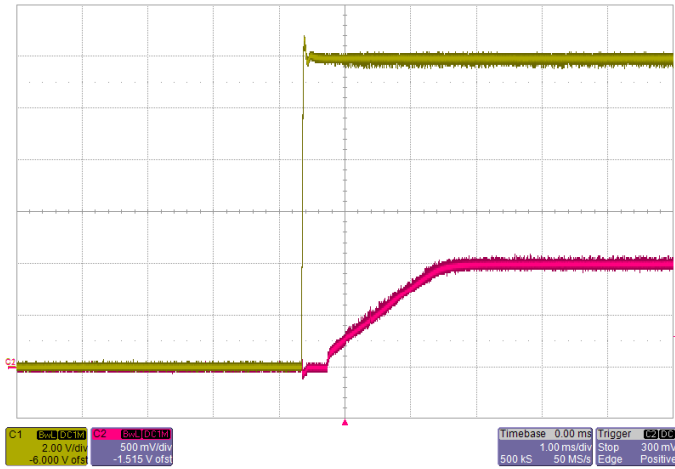

Start-up $V_{IN}=12V$, $I_O=6A$
(C2: Output,C1: Input)

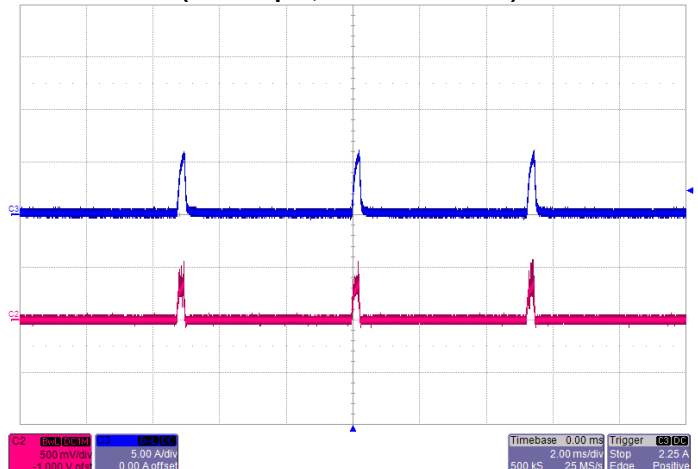

Short-Circuit Output $V_{IN}=12V$
(C2: Output voltage,C3: output current)

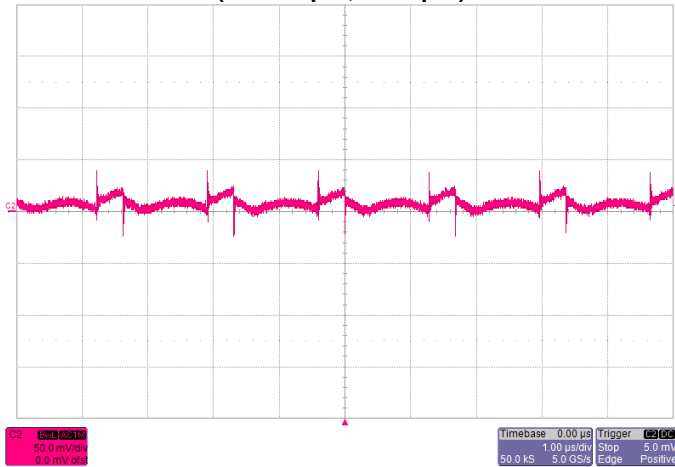

Noise $V_{IN}=5V$, $I_O=6A$, 5~20MHz Bandwidth

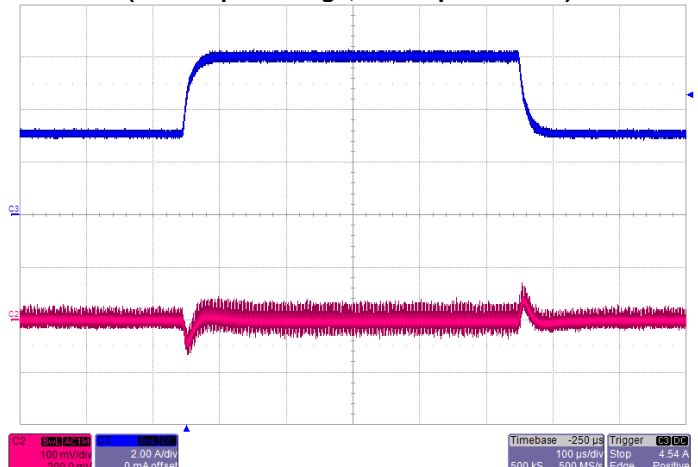

Transient Response $V_{IN}=5V$, Step from 3A~6A~3A
(C1: Output,C3: Load current)

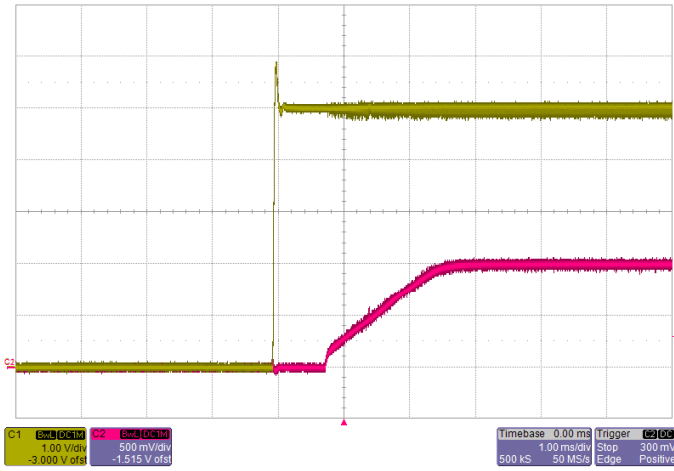

Start-up $V_{IN}=5V$, $I_o=6A$
(C2: Output, C1: Input)

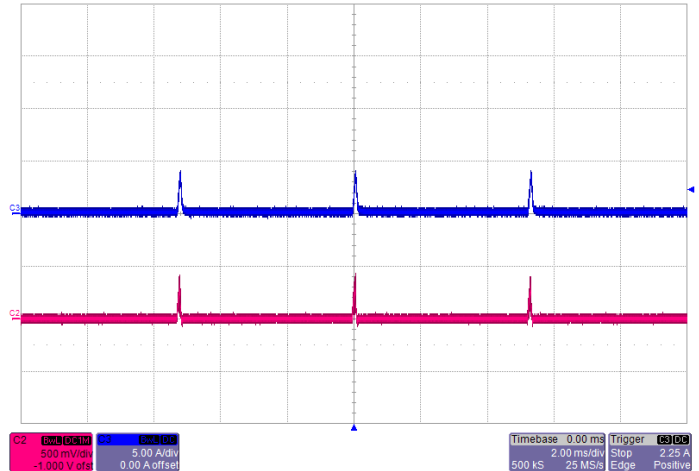

Short-Circuit Output $V_{IN}=5V$
(C2: Output voltage, C3: output current)

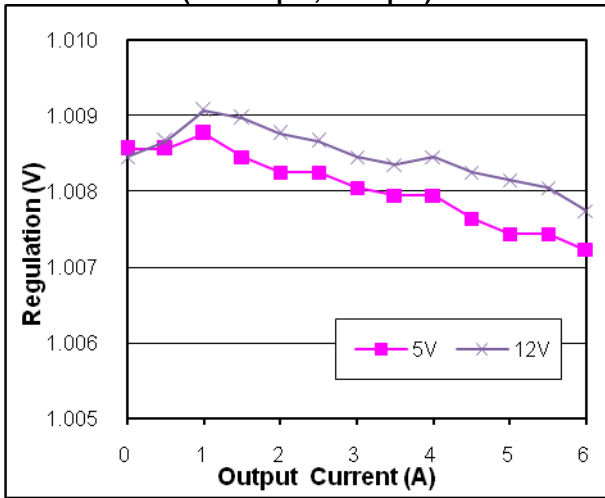

Regulation
Output voltage vs. Load Current,

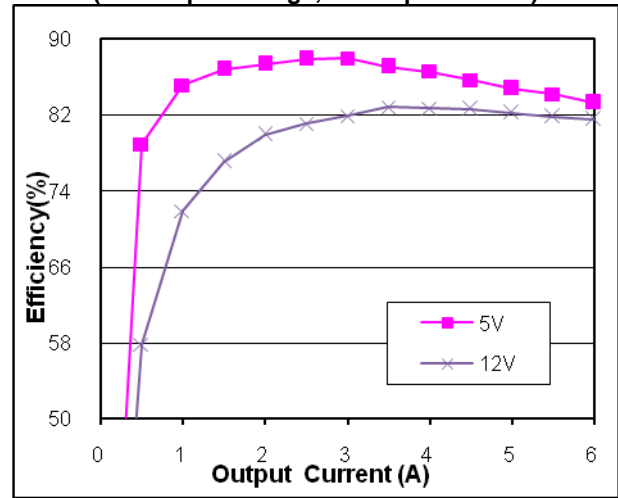

Efficiency

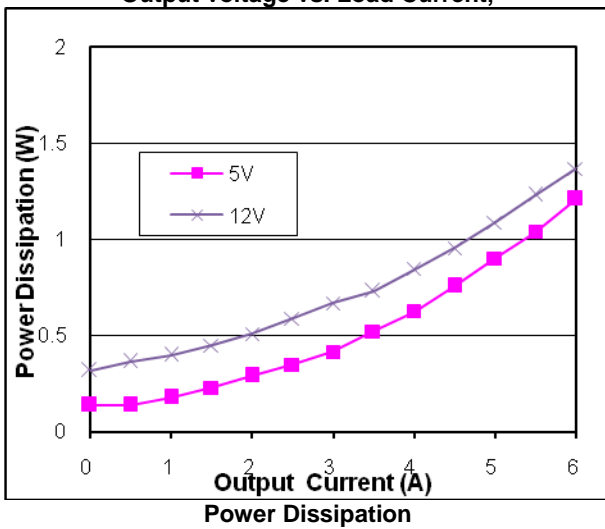

Power Dissipation

TBD

Output Current Derating (Load Current vs. Ambient Temperature (T_{REF} , See Page 6)), $V_{IN}=12V$,

Typical Characteristics – output adjusted to 1.2V

General conditions:

Input filter: 150µF TAN (150mΩ ESR), Output filter: 100µF TAN (150mΩ ESR)

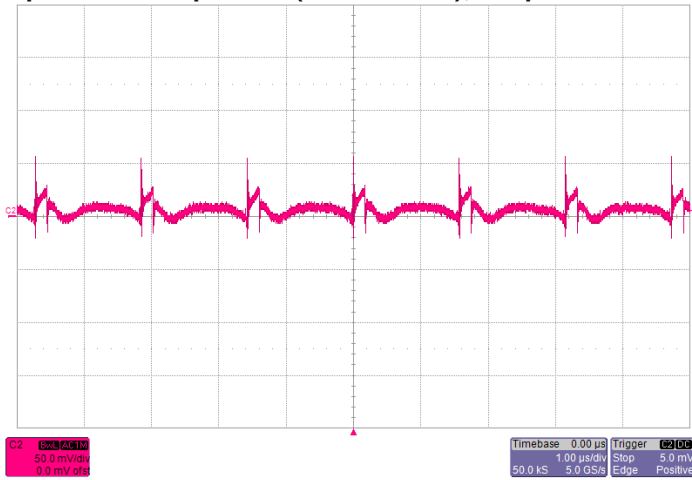

Noise $V_{IN}=12V$, $I_O=6A$, 5~20MHz Bandwidth

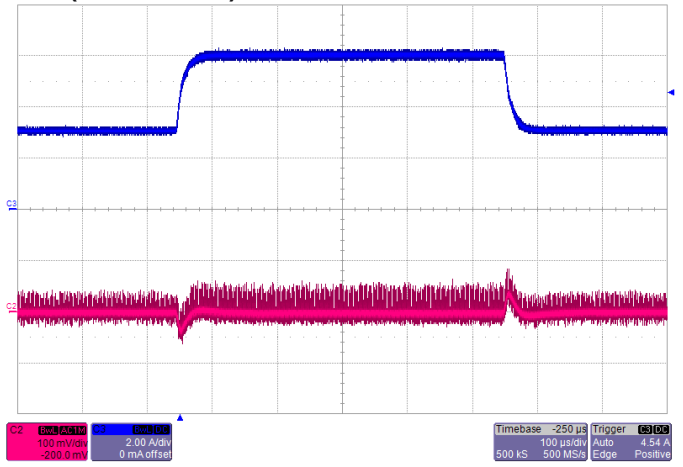

Transient Response $V_{IN}=12V$, Step from 3A~6A~3A
(C2: Output,C3: Load current)

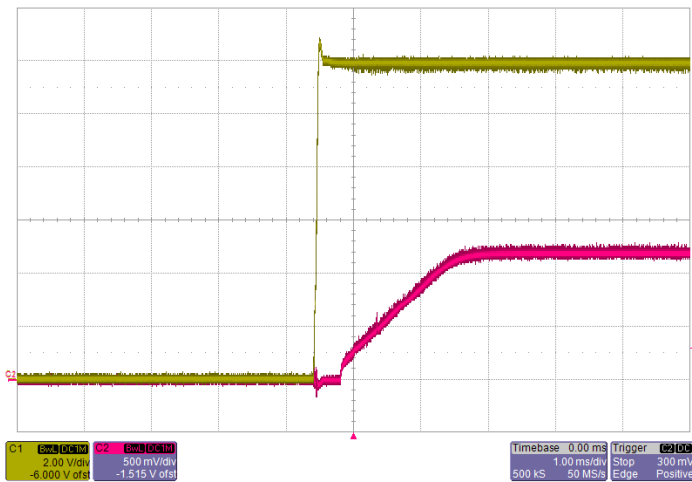

Start-up $V_{IN}=12V$, $I_O=6A$
(C2: Output,C1: Input)

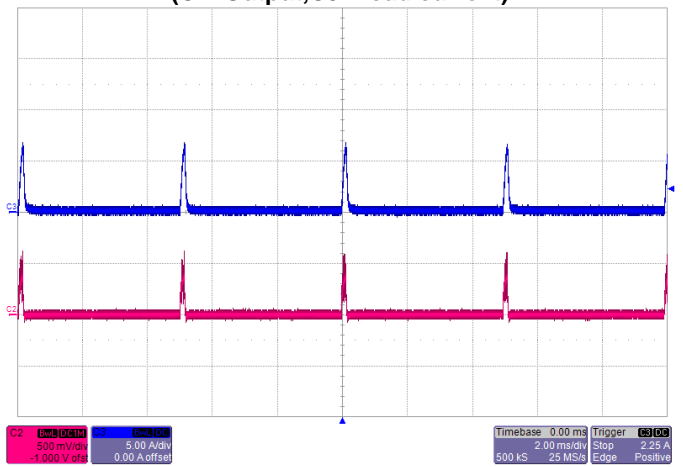

Short-Circuit Output $V_{IN}=12V$
(C2: Output voltage,C3: output current)

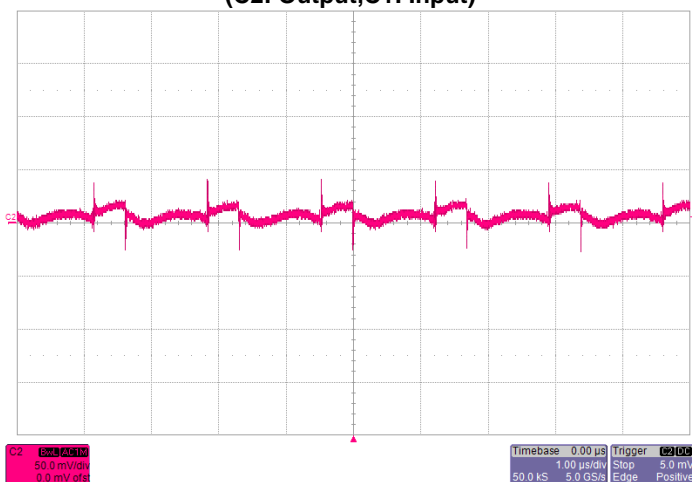

Noise $V_{IN}=5V$, $I_O=6A$, 5~20MHz Bandwidth

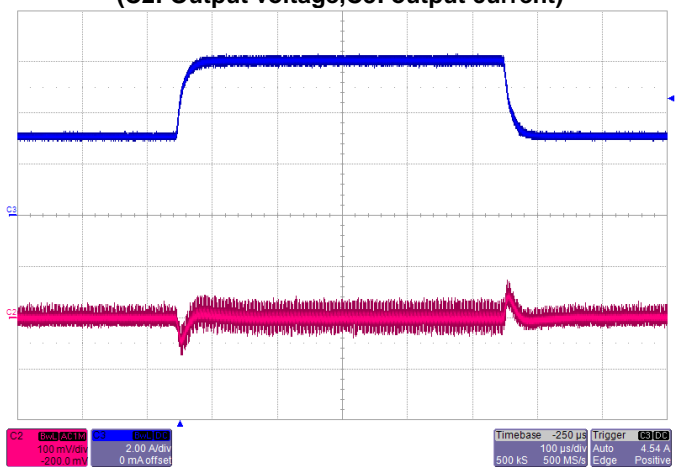

Transient Response $V_{IN}=5V$, Step from 3A~6A~3A
(C1: Output,C3: Load current)

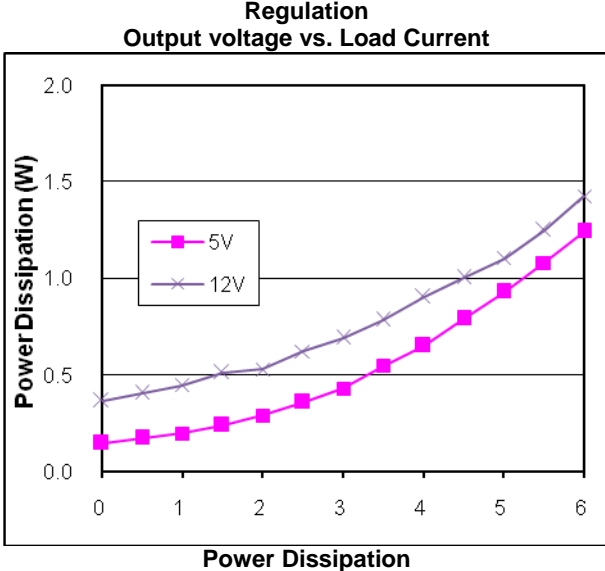
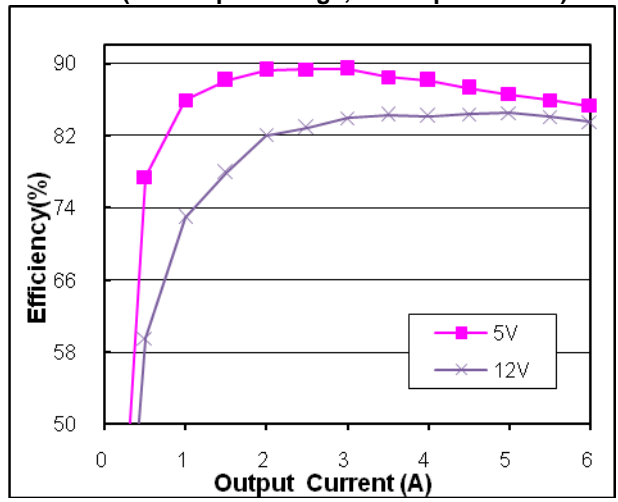
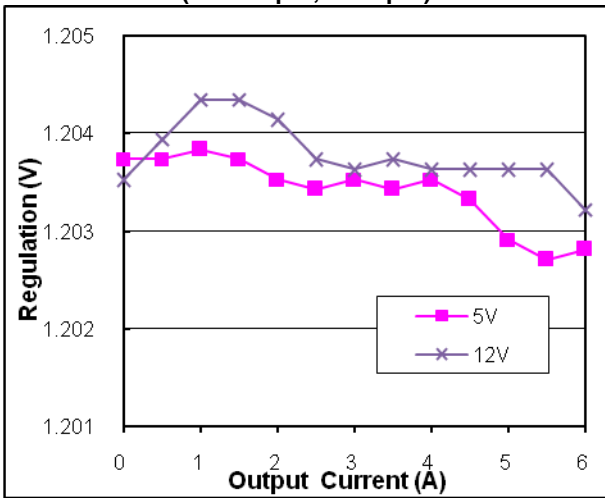
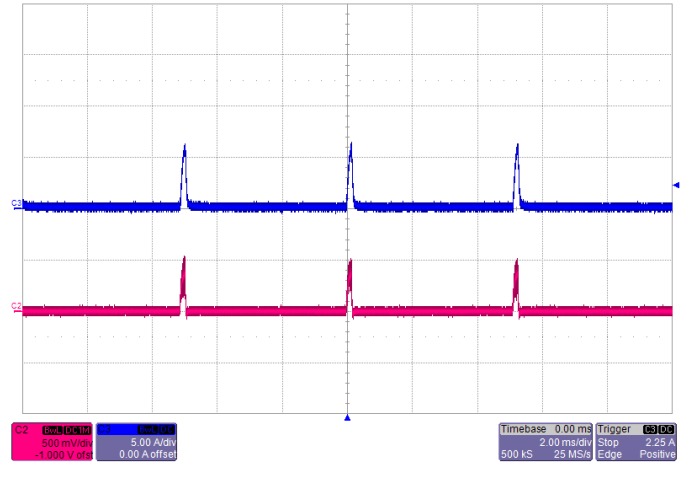
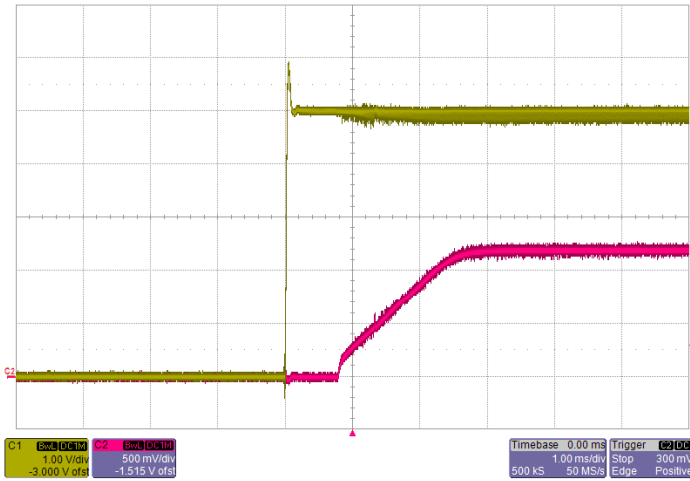

TBD

Output Current Derating (Load Current vs. Ambient Temperature (T_{REF} , See Page 6)), $V_{IN}=12V$,

Typical Characteristics – output adjusted to 1.5V

General conditions:

Input filter: 150µF TAN (150mΩ ESR), Output filter: 100µF TAN (150mΩ ESR)

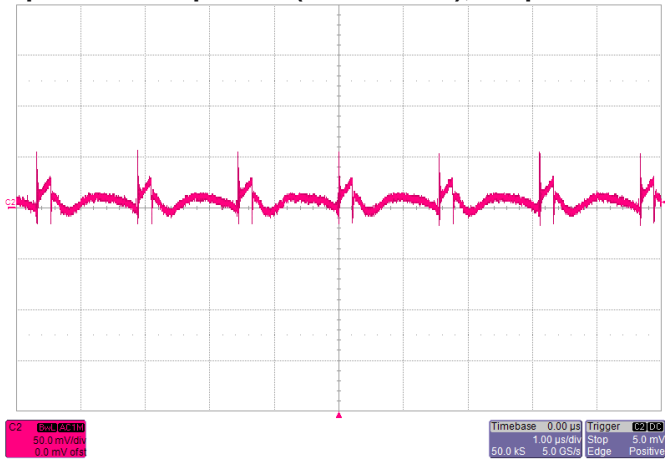

Noise $V_{IN}=12V$, $I_O=6A$, 5~20MHz Bandwidth

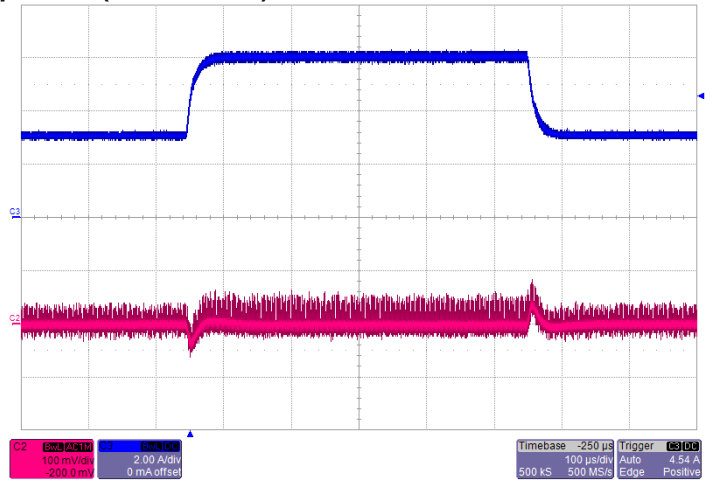

Transient Response $V_{IN}=12V$, Step from 3A~6A~3A (C2: Output,C3: Load current)

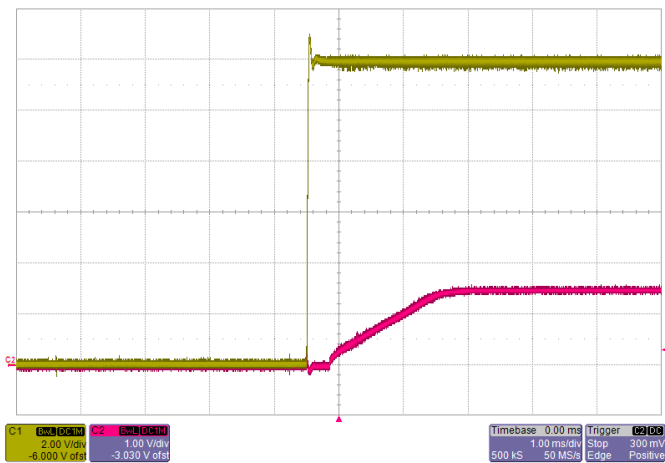

Start-up $V_{IN}=12V$, $I_O=6A$ (C2: Output,C1: Input)

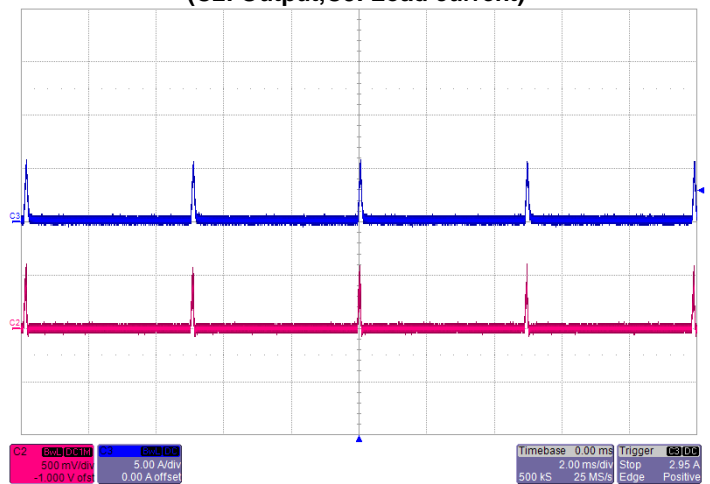

Short-Circuit Output $V_{IN}=12V$ (C2: Output voltage,C3: output current)

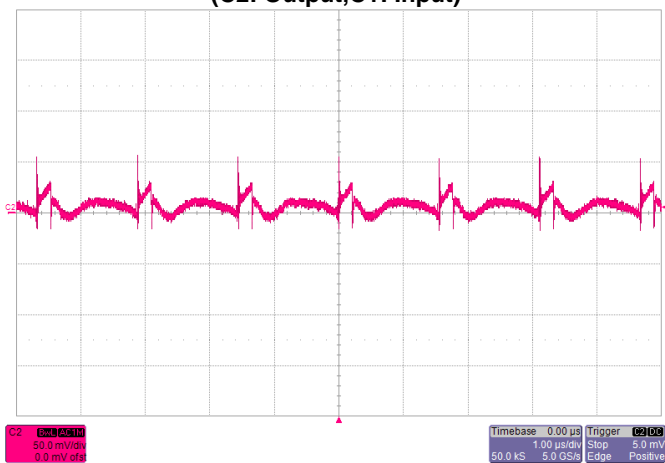

Noise $V_{IN}=5V$, $I_O=6A$, 5~20MHz Bandwidth

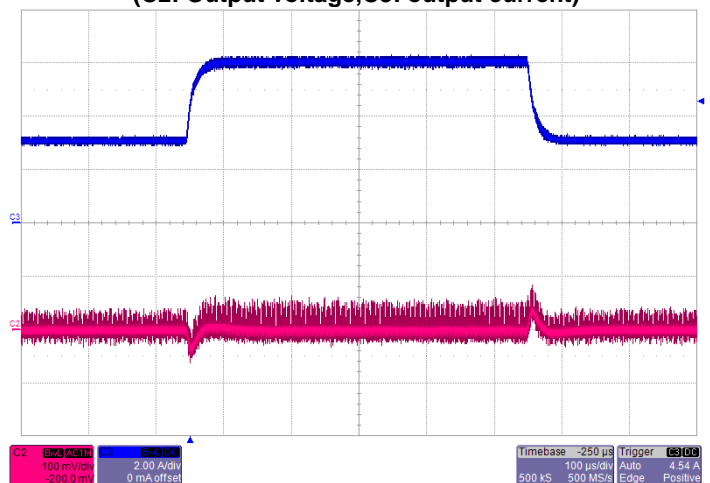

Transient Response $V_{IN}=5V$, Step from 3A~6A~3A (C1: Output,C3: Load current)

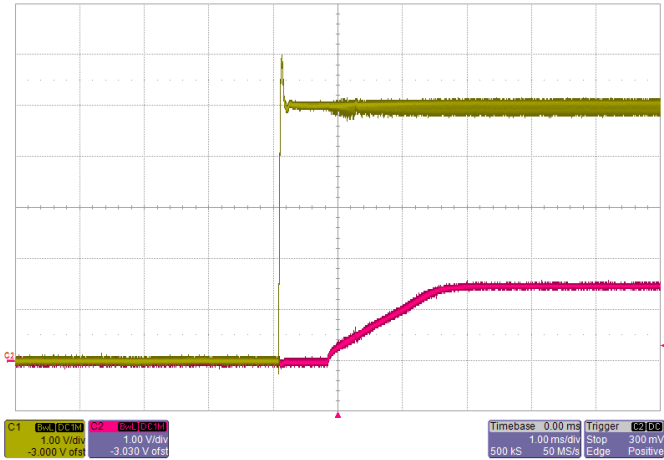

Start-up $V_{IN}=5V, I_o=6A$
(C2: Output, C1: Input)

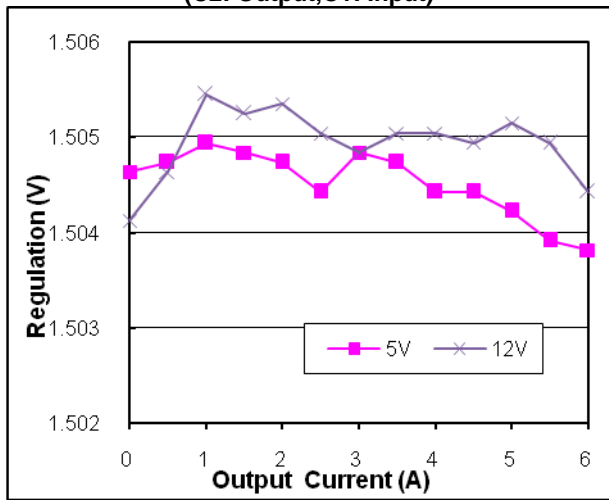

Regulation
Output voltage vs. Load Current,

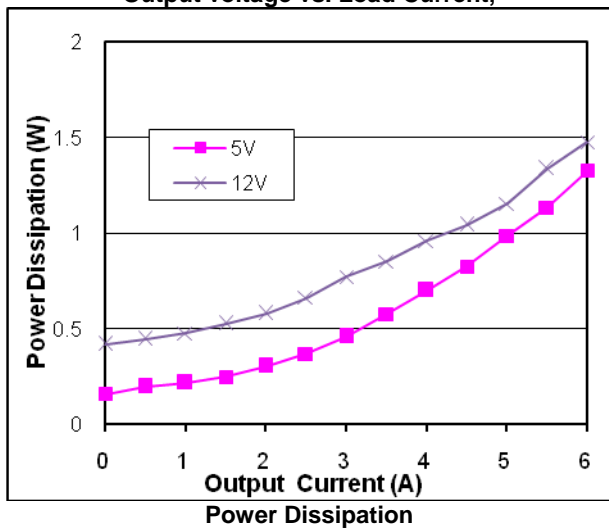

Power Dissipation

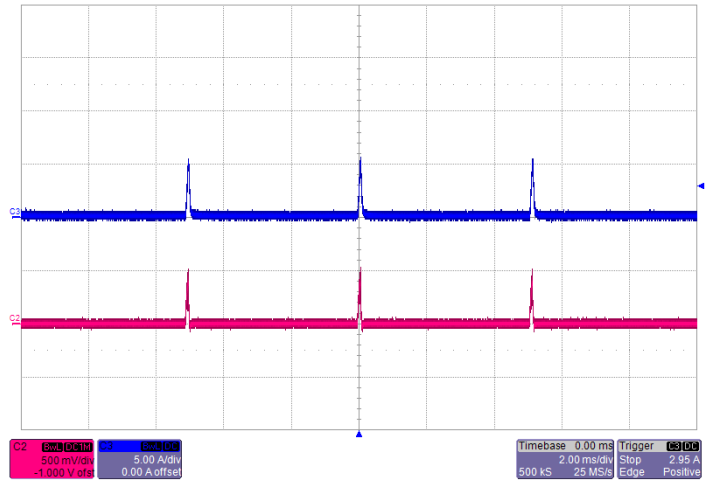

Short-Circuit Output $V_{IN}=5V$
(C2: Output voltage, C3: output current)

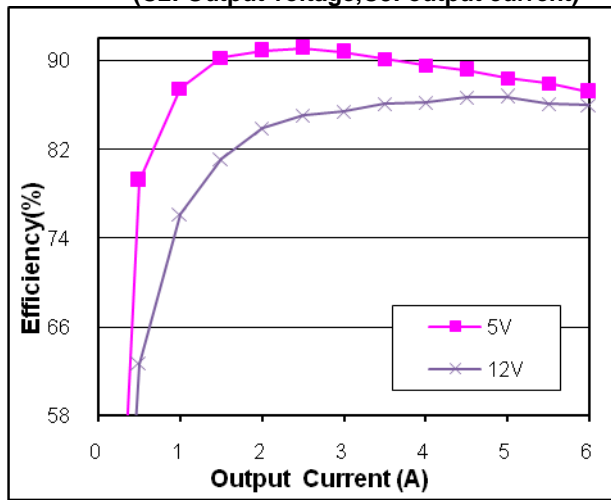

Efficiency

TBD

Output Current Derating (Load Current vs. Ambient Temperature (T_{REF} , See Page 6)), $V_{IN}=12V$,

Typical Characteristics – output adjusted to 1.8V

General conditions:

Input filter: 150µF TAN (150mΩ ESR), Output filter: 100µF TAN (150mΩ ESR)

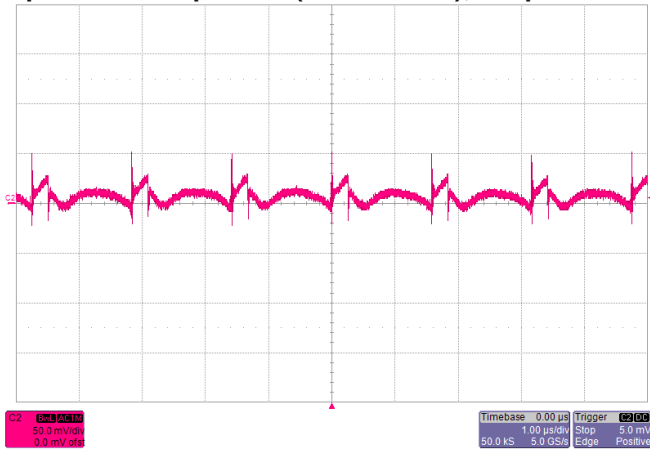

Noise $V_{IN}=12V$, $I_O=6A$, 5~20MHz Bandwidth

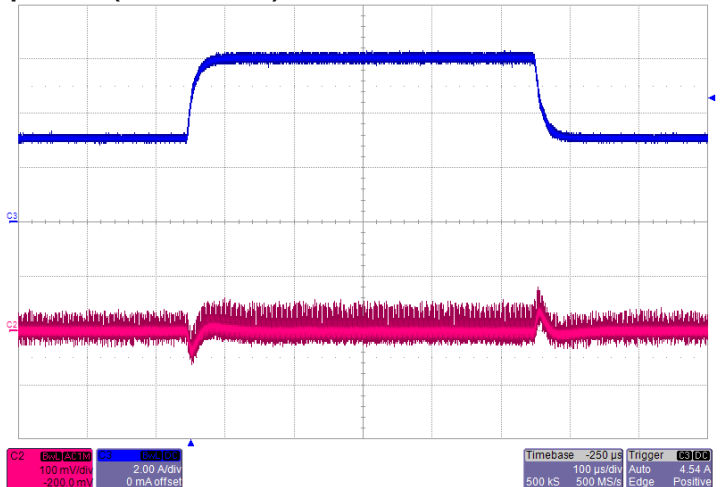

Transient Response $V_{IN}=12V$, Step from 3A~6A~3A (C2: Output, C3: Load current)

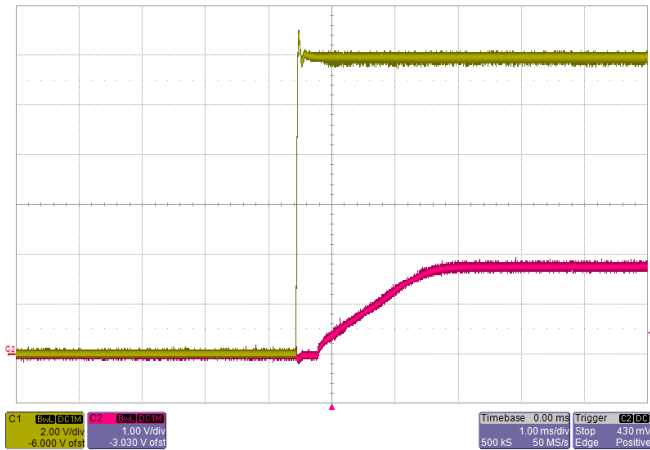

Start-up $V_{IN}=12V$, $I_O=6A$ (C2: Output, C1: Input)

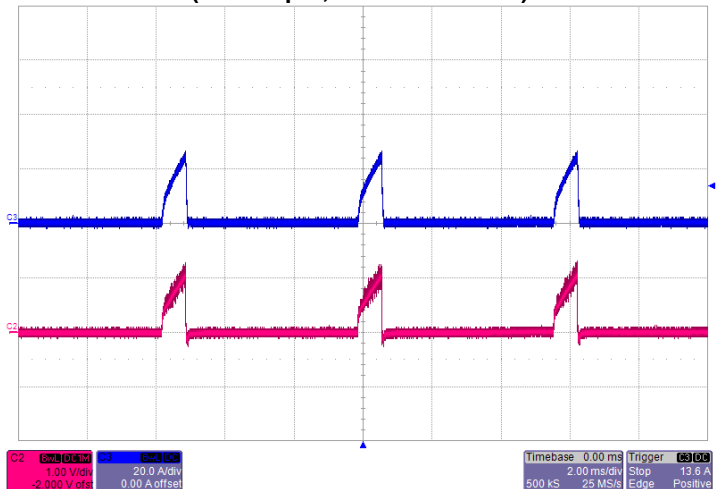

Short-Circuit Output $V_{IN}=12V$ (C2: Output voltage, C3: output current)

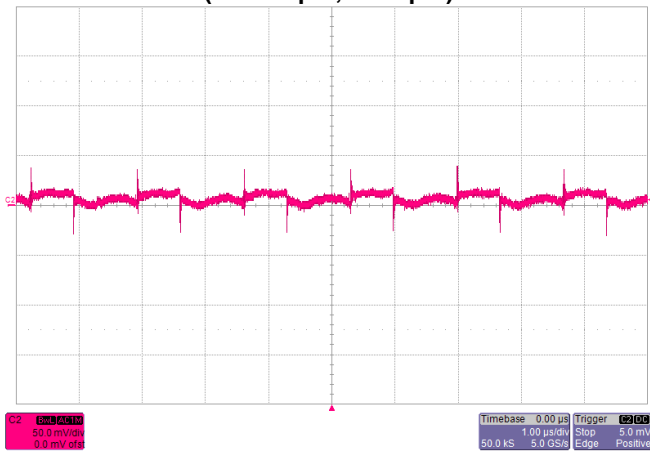

Noise $V_{IN}=5V$, $I_O=6A$, 5~20MHz Bandwidth

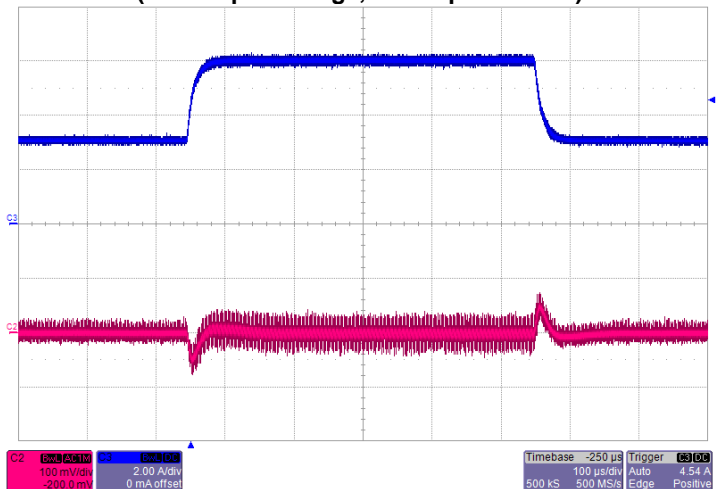

Transient Response $V_{IN}=5V$, Step from 3A~6A~3A (C2: Output, C3: Load current)

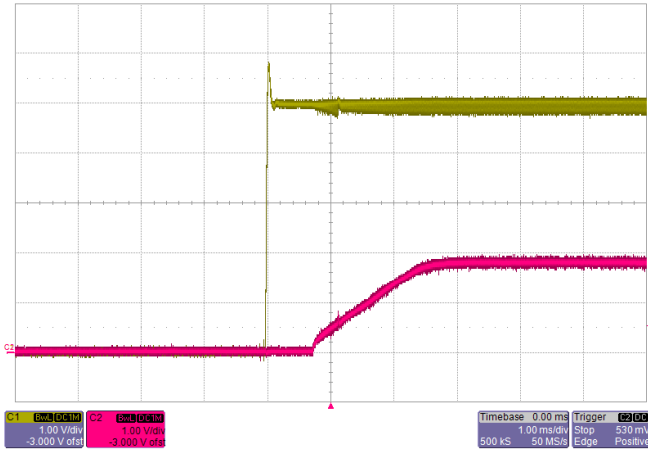

Start-up $V_{IN}=5V$, $I_O=6A$
(C2: Output, C1: Input)

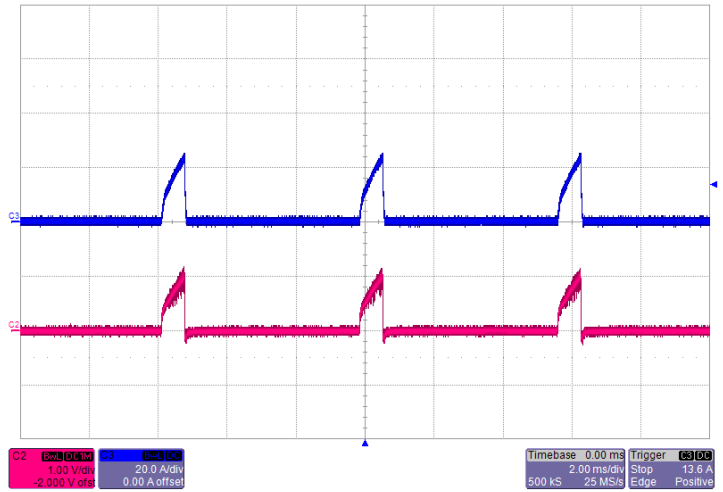

Short-Circuit Output $V_{IN}=5V$
(C2: Output voltage, C3: output current)

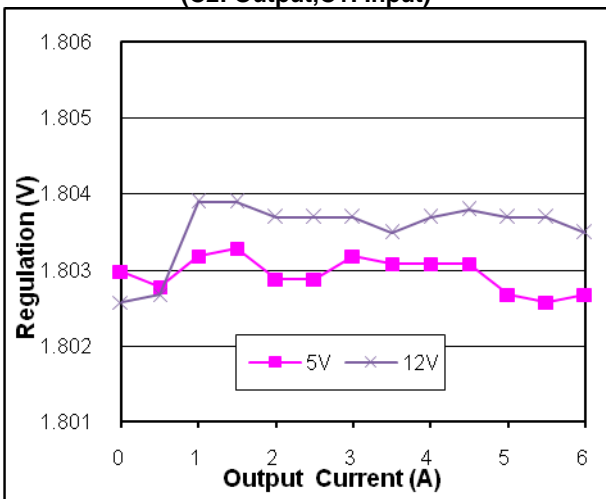

Regulation
Output voltage vs. Load Current

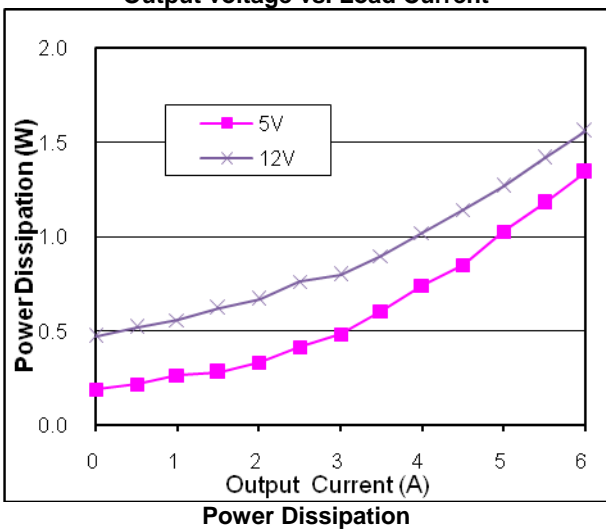
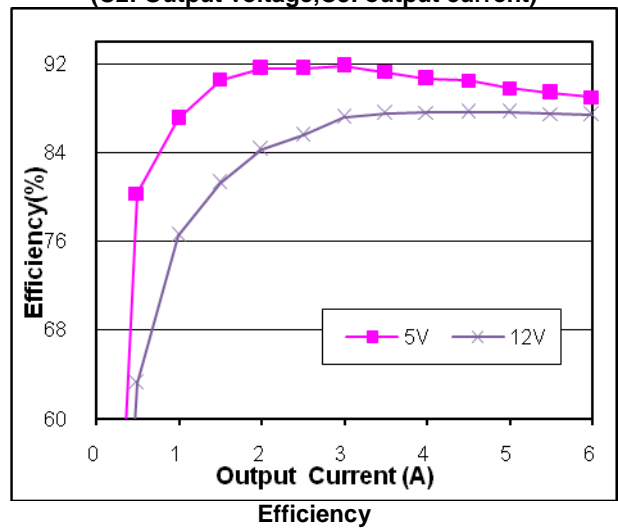

Power Dissipation

TBD

Output Current Derating (Load Current vs. Ambient Temperature (T_{REF} , See Page 6)), $V_{IN}=12V$,

Typical Characteristics – output adjusted to 2.5V

General conditions:

Input filter: 150µF TAN (150mΩ ESR), Output filter: 100µF TAN (150mΩ ESR)

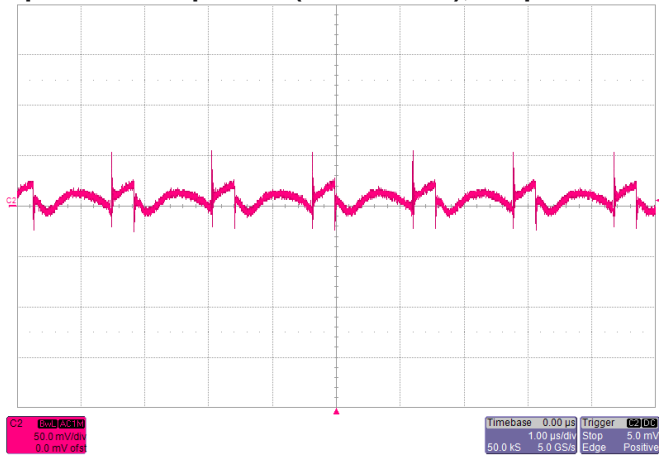

Noise VIN=12V, IO=6A, 5~20MHz Bandwidth

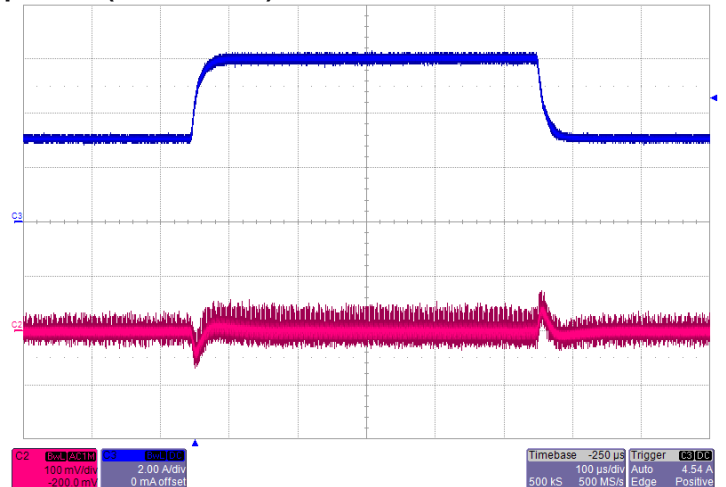

Transient Response VIN=12V, Step from 3A~6A~3A (C2: Output,C3: Load current)

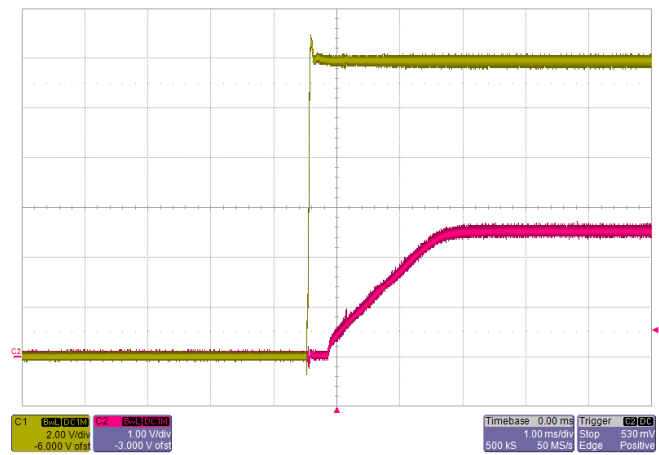

Start-up VIN=12V, IO=6A (C2: Output,C1: Input)

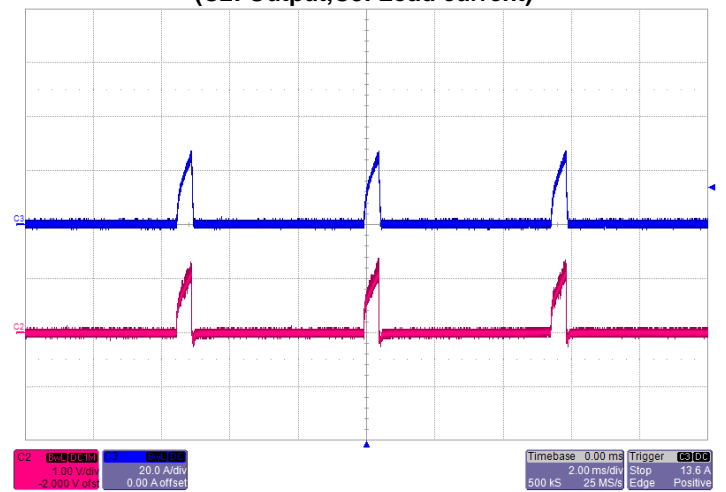

Short-Circuit Output VIN=12V (C2: Output voltage,C3: output current)

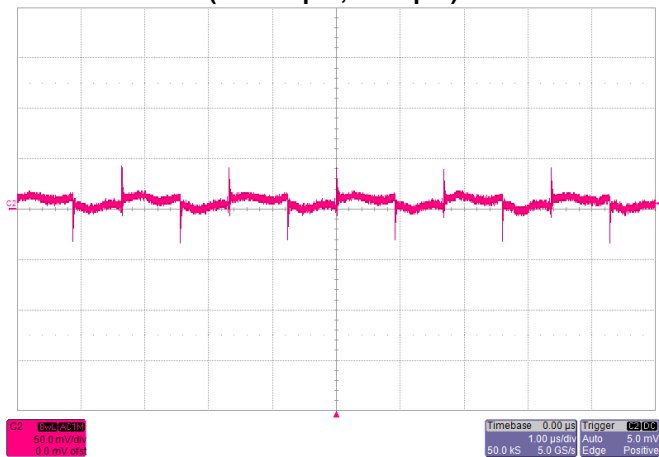

Noise VIN=5V, IO=6A, 5~20MHz Bandwidth

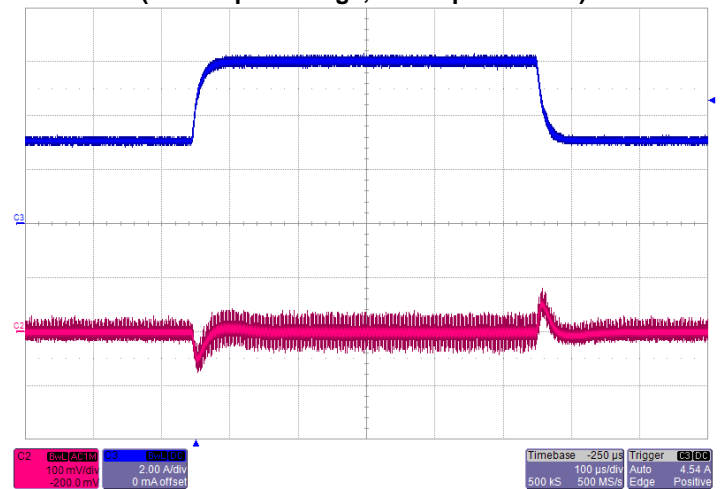

Transient Response VIN=5V, Step from 3A~6A~3A (C2: Output,C3: Load current)

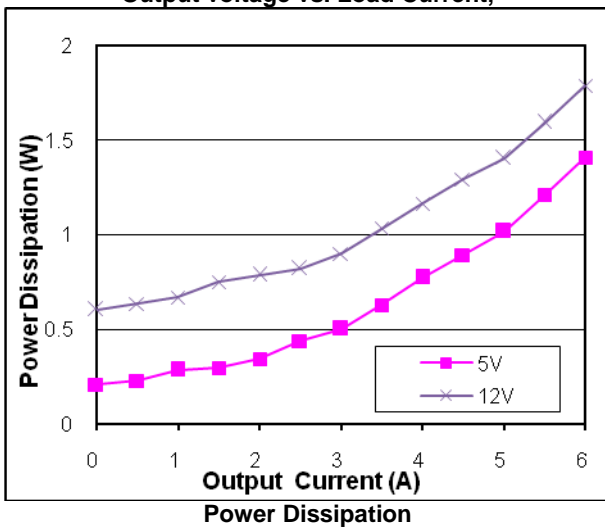
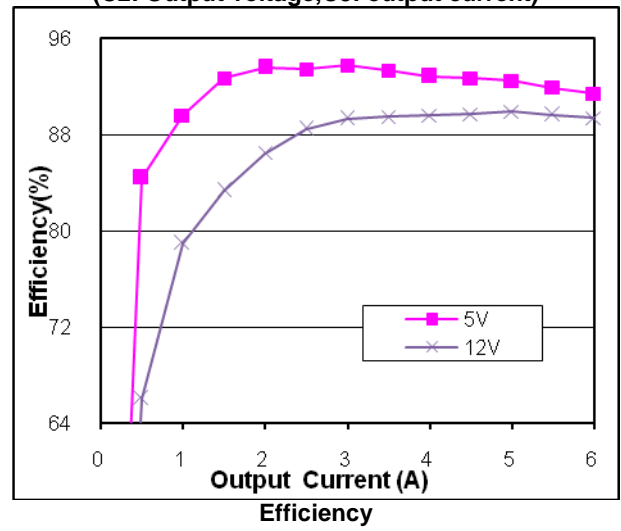
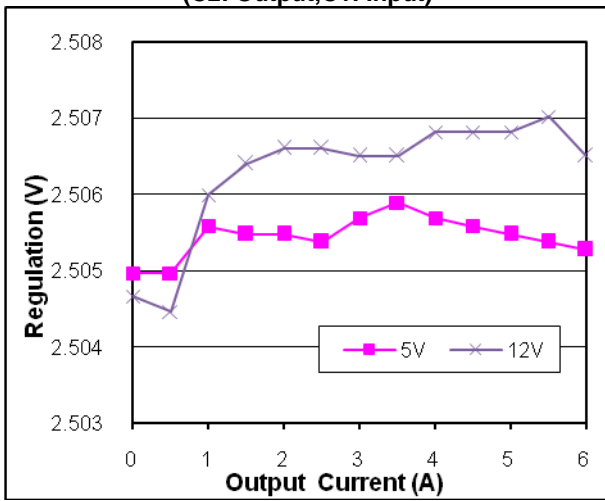
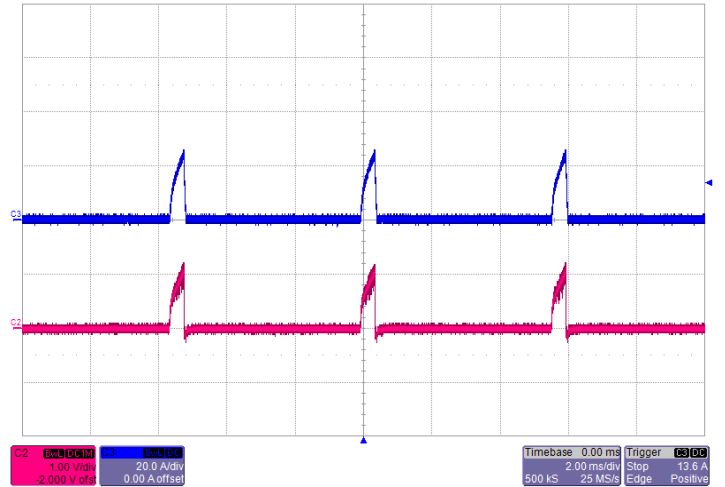
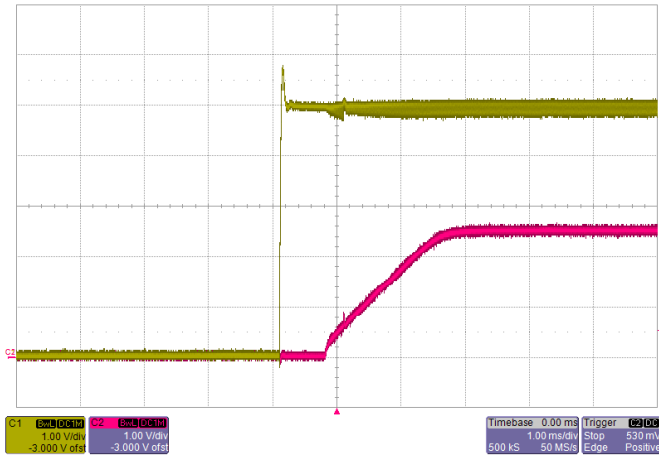

TBD

Output Current Derating (Load Current vs. Ambient Temperature (T_{REF} , See Page 6)), $V_{IN}=12V$,

Typical Characteristics – output adjusted to 3.3V

General conditions:

Input filter: 150µF TAN (150mΩ ESR), Output filter: 100µF TAN (150mΩ ESR)

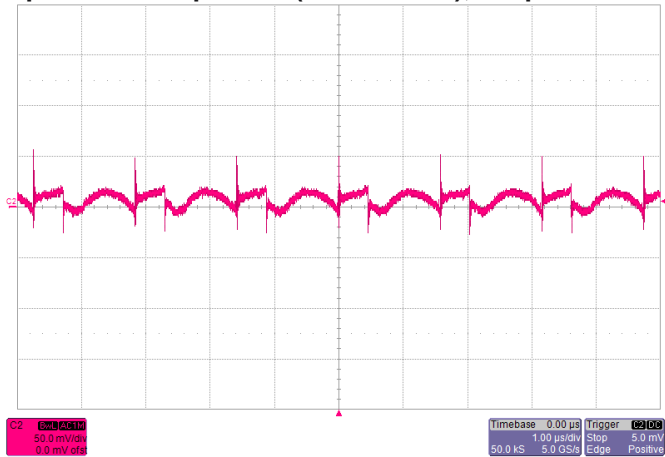

Noise $V_{IN}=12V$, $I_O=6A$, 5~20MHz Bandwidth

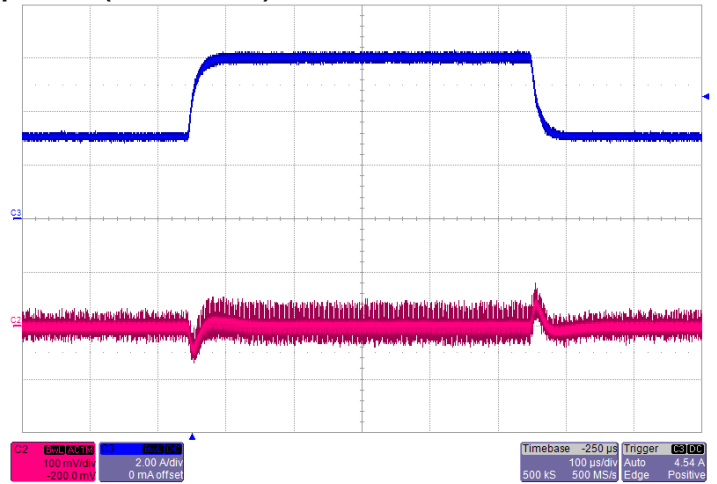

Transient Response $V_{IN}=12V$, Step from 3A~6A~3A
(C2: Output,C3: Load current)

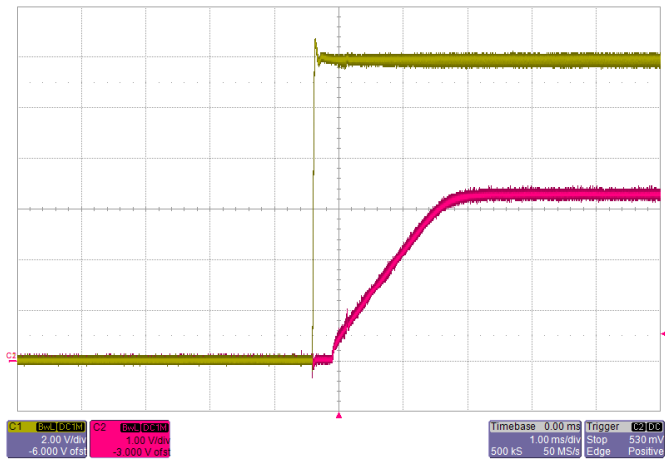

Start-up $V_{IN}=12V$, $I_O=6A$
(C2: Output,C1: Input)

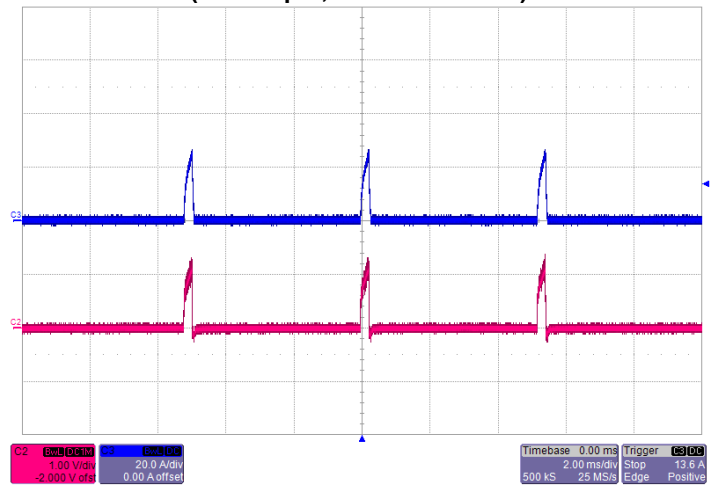

Short-Circuit Output $V_{IN}=12V$
(C2: Output voltage,C3: output current)

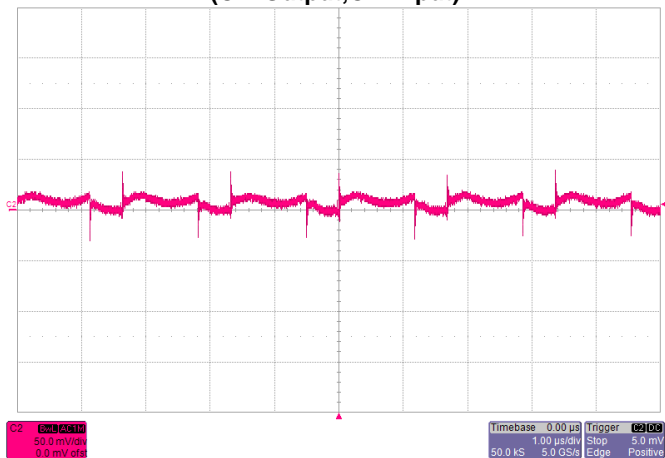

Noise $V_{IN}=5V$, $I_O=6A$, 5~20MHz Bandwidth

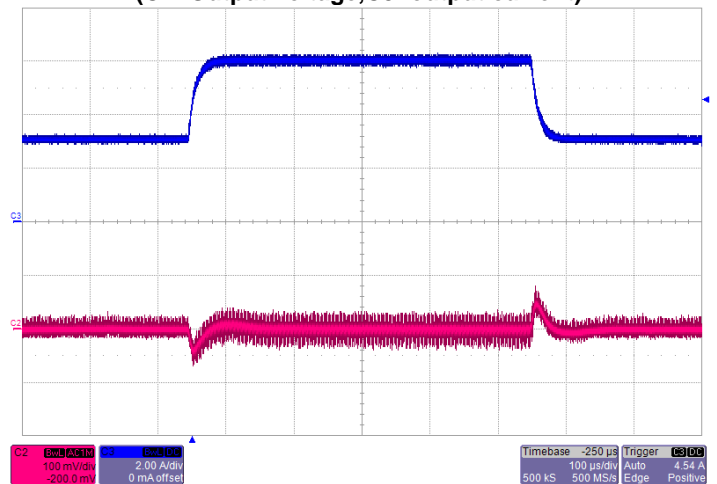

Transient Response $V_{IN}=5V$, Step from 3A~6A~3A
(C2: Output,C3: Load current)

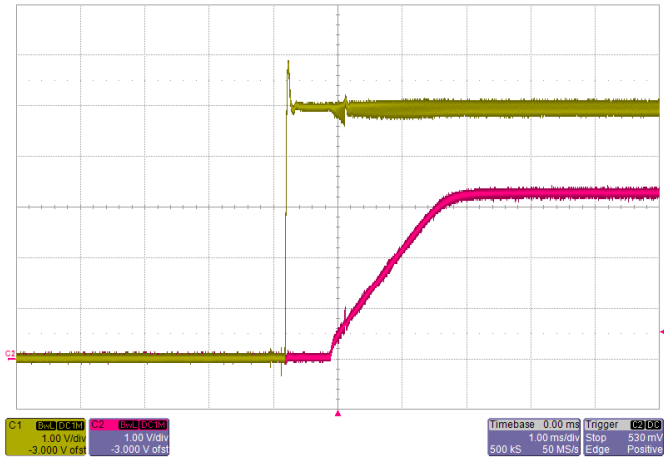

Start-up $V_{IN}=5V$, $I_o=6A$
(C2: Output, C1: Input)

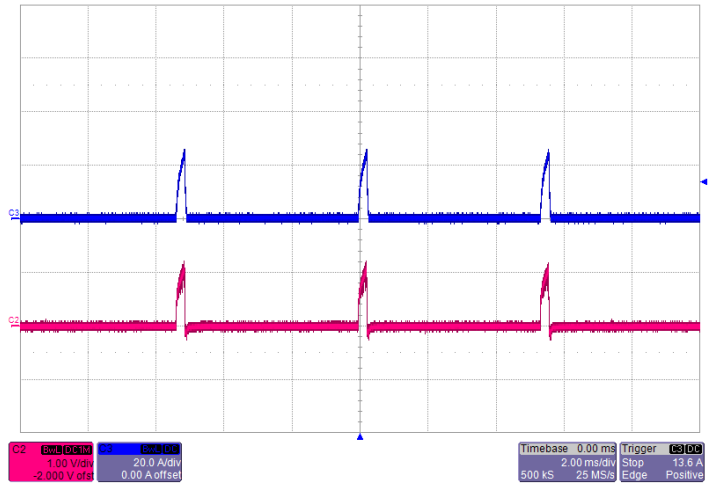

Short-Circuit Output $V_{IN}=5V$
(C2: Output voltage, C3: output current)

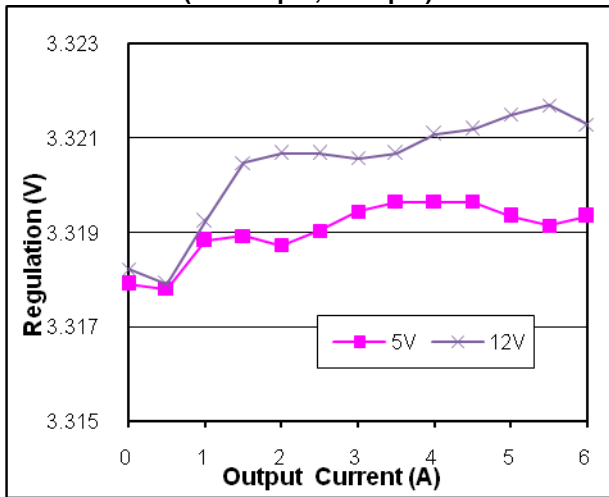

Regulation
Output voltage vs. Load Current,

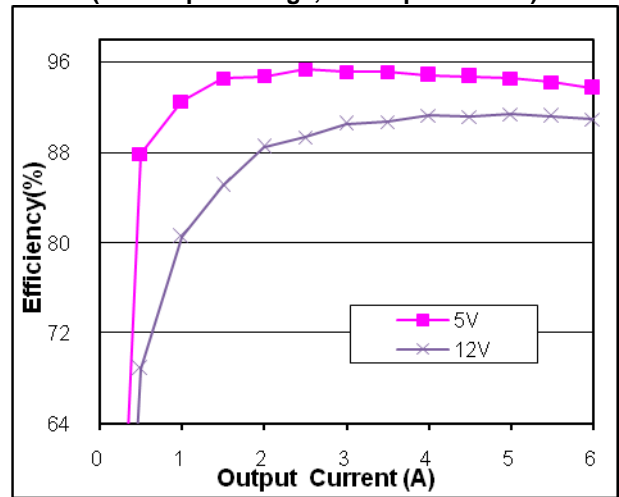

Efficiency

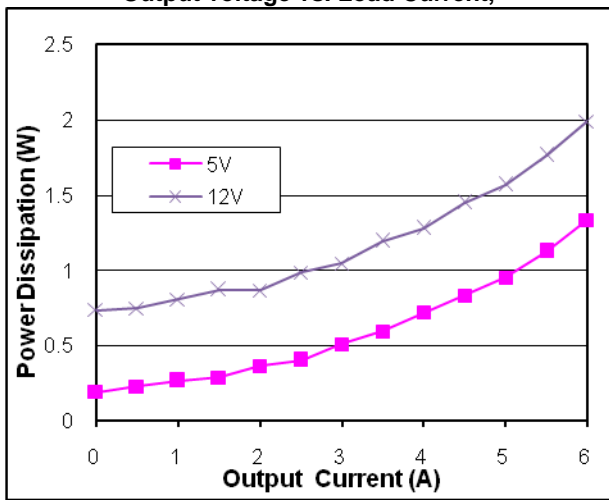

Power Dissipation

TBD

Output Current Derating (Load Current vs. Ambient Temperature (T_{REF} , See Page 6)), $V_{IN}=12V$,

Typical Characteristics – output adjusted to 5.0V

General conditions:

Input filter: 150µF TAN (150mΩ ESR), Output filter: 100µF TAN (150mΩ ESR)

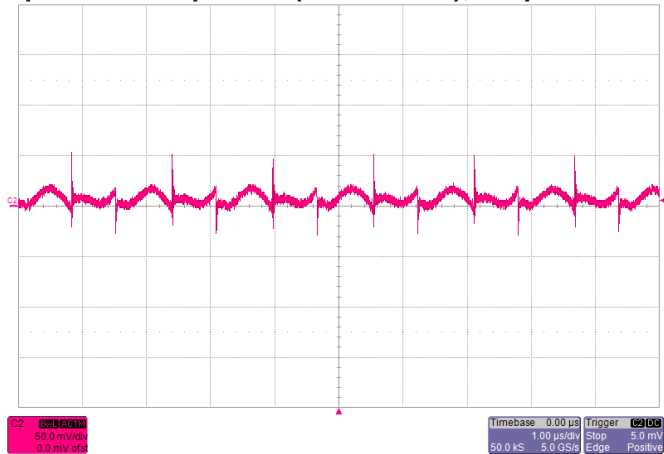

Noise $V_{IN}=12V$, $I_o=6A$, 5~20MHz Bandwidth

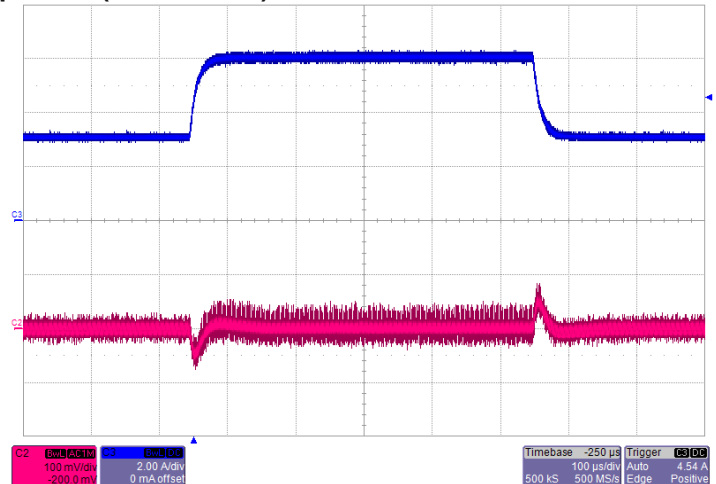

Transient Response $V_{IN}=12V$, Step from 3A~6A~3A (C2: Output,C3: Load current)

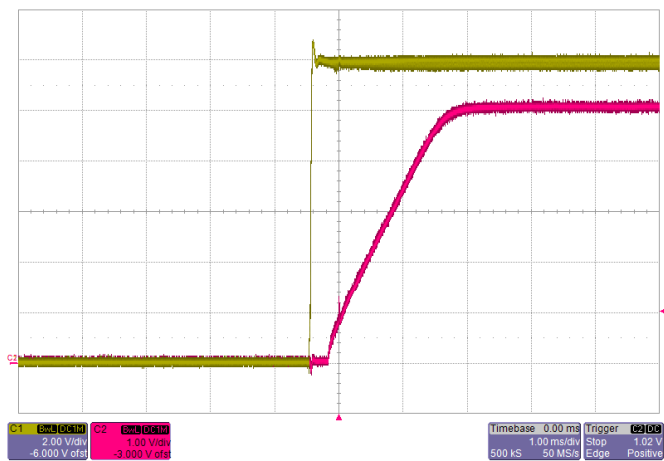

Start-up $V_{IN}=12V$, $I_o=6A$ (C2: Output,C1: Input)

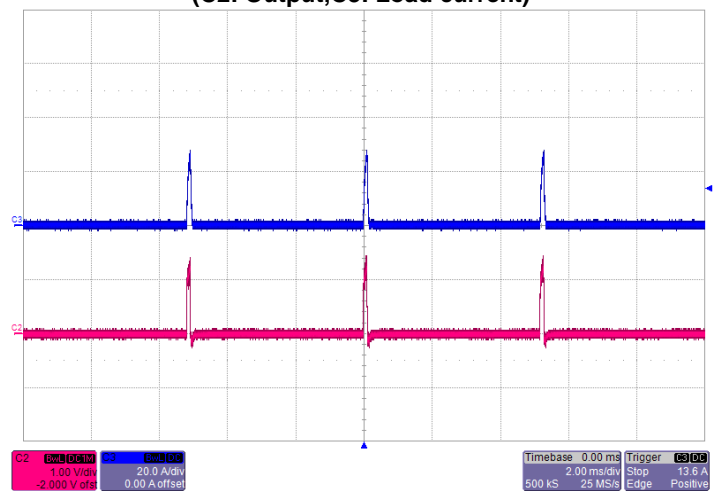

Short-Circuit Output $V_{IN}=12V$ (C2: Output voltage,C3: output current)

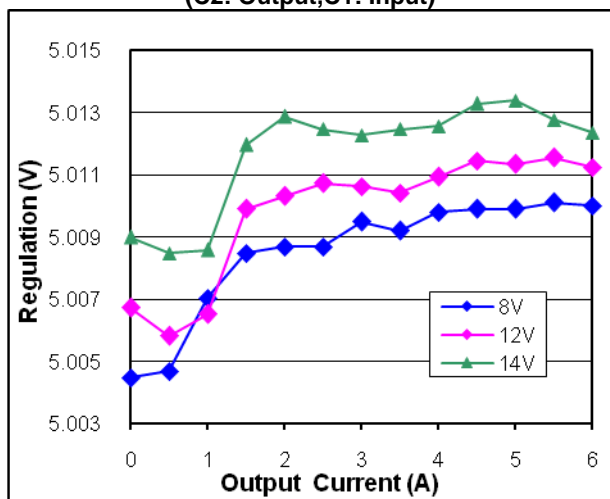

Regulation Output voltage vs. Load Current,

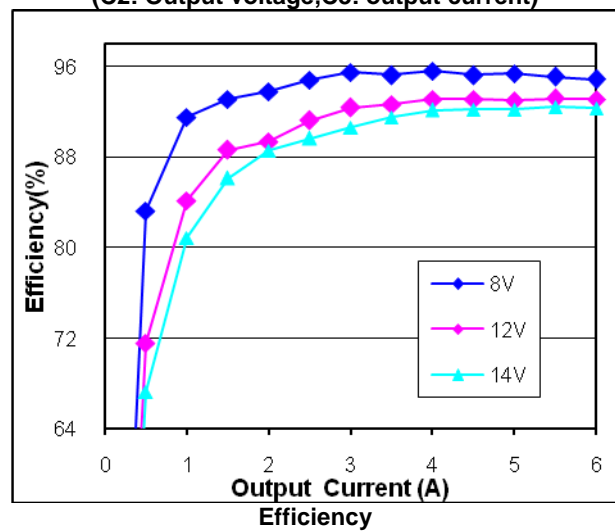

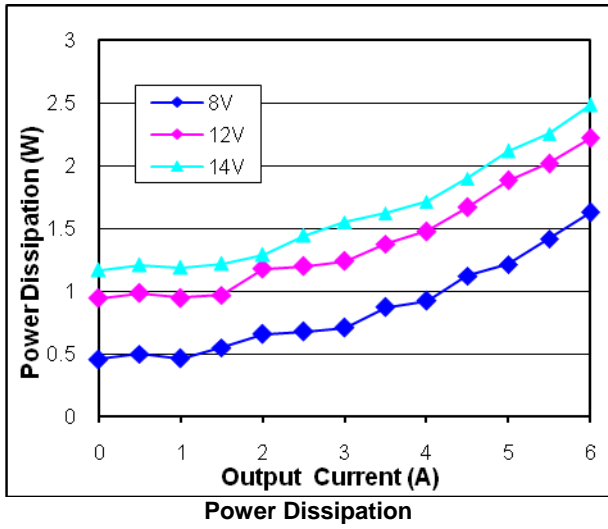

TBD

Output Current Derating (Load Current vs. Ambient Temperature (T_{REF} , See Page 6)), $V_{IN}=12V$,

Recommended PAD Pattern

Dimensions are in millimeters (inches)
 Tolerances: x.xx in ± 0.02 in (x.x mm ± 0.5 mm);
 x.xxx in ± 0.01 in (x.xx mm ± 0.25 mm)

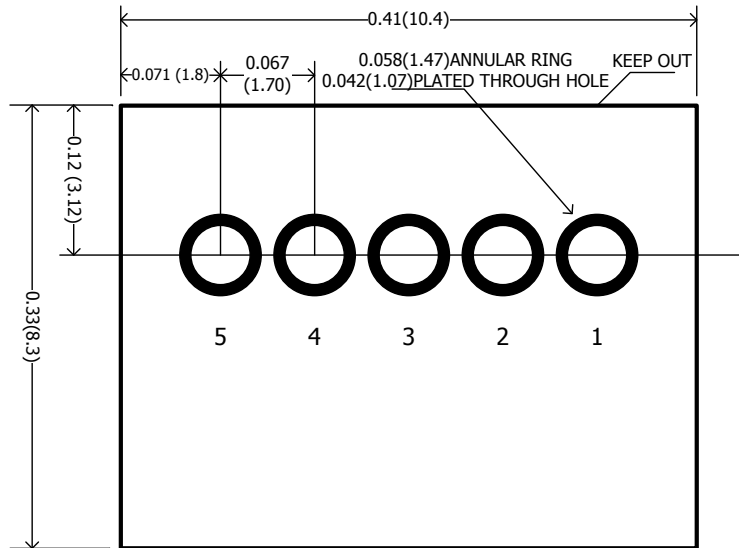

| PIN | Description |
|-----|-------------|
| 1 | ON/OFF |
| 2 | Vin, input |
| 3 | GND |
| 4 | Vo, output |
| 5 | Trim |

COMPONENT-SIDE FOOTPRINT

with -B option

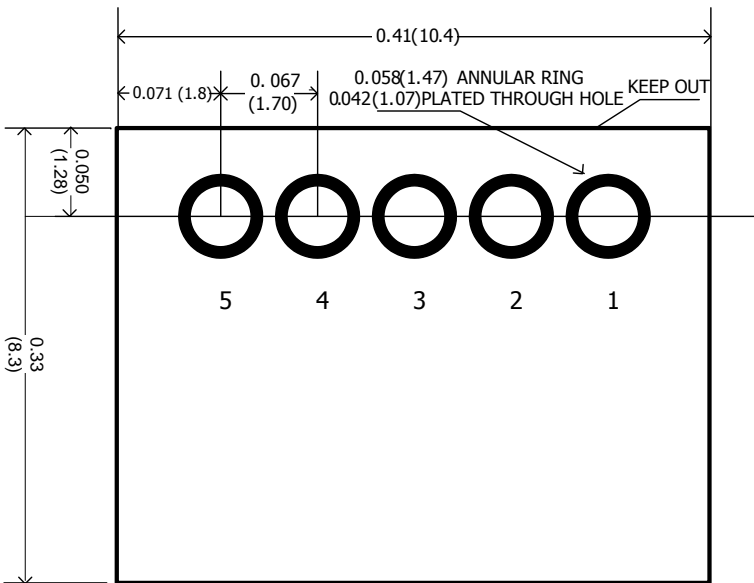

| PIN | Description |
|-----|-------------|
| 1 | ON/OFF |
| 2 | Vin, input |
| 3 | GND |
| 4 | Vo, output |
| 5 | Trim |

Application Notes